



## Instruction Manual

# **Composite-ARF Extra 300SX, 2.6 m**



## **Instructions for Extra 300SX IMAC-Airplane**

Thank you very much for purchasing our Composite-ARF Extra 300SX all composite aircraft, made with the revolutionary Total Area Vacuum Sandwich (TAVS) technology

It is based on our extremely successful Extra 330L (2.6m), which has been in production for 5 years, and assembly is almost identical. Therefore this Instruction Manual is actually an updated version of our 330L manual, and you will see some photos of the original 330L kit here, in different colour schemes - so please don't get confused ! Of course, all the important areas that have changed are shown, and the main changes between the 2 airframes are:

- a) The 300SX has a Ø 40mm wing tube (instead of carbon blade spars)
- b) The motor-dome is now molded as an integral part of the fuselage.
- c) The Landing Gear mount is revised and reinforced, and LG leg cuffs are included.
- d) A shorter clear canopy, & the canopy frame fixings are completed at the factory.
- e) Elevator hinges now use the 4mm diameter tube system, instead of the 2mm Ø wires.
- f) The Tank base and Rudder servo tray are modified to fit the wing tube structure.

*\* Instructions version 1.01 update includes note about wing tube length.*

Before you get started building and setting-up your aircraft, please make sure you have read this instruction manual several times, and understood it. If you have any questions, please don't hesitate to contact us. Below are the contact details:

**Email:** [feedback@composite-arf.com](mailto:feedback@composite-arf.com)  
**or** [techsupport@composite-arf.com](mailto:techsupport@composite-arf.com)  
**Telephone:** Phone your C-ARF Rep!!! He will be there for you.  
**Website:** <http://www.composite-arf.com>

## **Liability Exclusion and Damages**

You have acquired a kit, which can be assembled into a fully working R/C model when fitted out with suitable accessories, as described in the instruction manual with the kit.

However, as manufacturers, we at Composite-ARF are not in a position to influence the way you build and operate your model, and we have no control over the methods you use to install, operate and maintain the radio control system components. For this reason we are obliged to deny all liability for loss, damage or costs which are incurred due to the incompetent or incorrect application and operation of our products, or which are connected with such operation in any way. Unless otherwise prescribed by binding law, the obligation of the Composite-ARF company to pay compensation is excluded, regardless of the legal argument employed.

This applies to personal injury, death, damage to buildings, loss of turnover and business, interruption of business or other direct and indirect consequent damages. In all circumstances our total liability is limited to the amount which you actually paid for this model.

**BY OPERATING THIS MODEL YOU ASSUME FULL RESPONSIBILITY FOR YOUR ACTIONS.**

It is important to understand that Composite-ARF Co., Ltd, is unable to monitor whether you follow the instructions contained in this instruction manual regarding the construction, operation and maintenance of the aircraft, nor whether you install and use the radio control system correctly. For this reason we at Composite-ARF are unable to guarantee or provide a contractual agreement with any individual or company that the model you have made will function correctly and safely. You, as operator of the model, must rely upon your own expertise and judgement in acquiring and operating this model.

## Supplementary Safety Notes

### Pre-flight checking:

Before every session check that all the model's working systems function correctly, and be sure to carry out a range check.

The first time you fly any new model aircraft we strongly recommend that you enlist the help of an experienced modeller to help you check the model and offer advice while you are flying. He should be capable of detecting potential weak points and errors.

Be certain to keep to the recommended CG position and control surface travels. If adjustments are required, carry them out before operating the model.

Be aware of any instructions and warnings of other manufacturers, whose product(s) you use to fly this particular aircraft, especially engines and radio equipment.

Please don't ignore our warnings, or those provided by other manufacturers. They refer to things and processes which, if ignored, could result in permanent damage or fatal injury.

## Attention !

This IMAC-Aircraft is a high-end product and can create an enormous risk for both pilot and spectators, if not handled with care, and used according to the instructions. Make sure that you operate your Extra according to the AMA rules, or those laws and regulations governing the model flying in the country of use.

The engine, servos and control surfaces have to be attached properly. Please use only the recommended engines, servos, propellers, and accessories supplied in the kit.

Make sure that the 'Centre of Gravity' is located in the recommended place. Use the nose heavy end of the CG range for your first flights, before you start moving the CG back to a more critical position for 3D-maneuvers. If you find that you need to relocate your batteries or even add weight in the aircraft to move the CG to the recommended position, please do so and don't try to save weight or hassle. A tail heavy plane, in a first flight, can be an enormous danger for you and all spectators. Fix any weights, and heavy items like batteries, very securely to the plane.

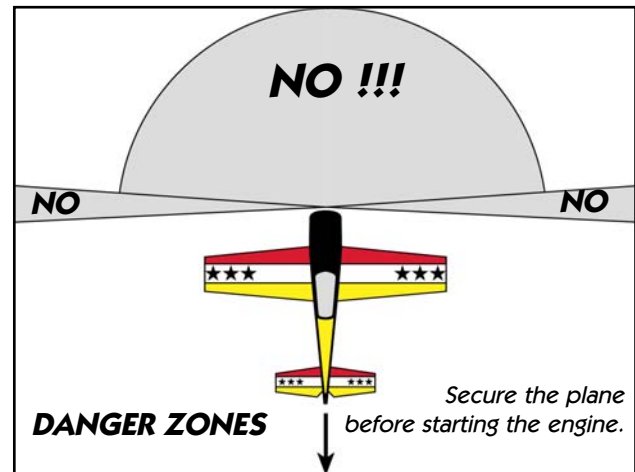

Make sure that the plane is secured properly when you start the engine. Have at least 2 helpers hold your plane from the tail end, or from behind the wing tips, before you start the engine. Make sure that all spectators are behind, or far in front, of the aircraft when running up the engine.

Make sure that you range check your R/C system thoroughly before the first flight. It is absolutely necessary to range check your complete R/C installation first WITHOUT the engine running. Leave the transmitter antenna retracted, and check the distance you can walk before 'fail-safe' occurs. Then start up the engine, run it at about half throttle and repeat this range check with the engine running. Make sure that there is no range reduction before 'fail-safe' occurs. Only then

make the 1st flight. If you feel that the range with engine running is less than with the engine off, please contact the radio supplier and the engine manufacturer and DON'T FLY at that time.

Check for vibrations through the whole throttle range. The engine should run smoothly with no unusual vibration. If you think that there are any excessive vibrations at any engine rpm's, DON'T FLY at this time and check your engine, spinner and propeller for proper balancing. The light-weight sandwich composite parts don't like too much vibration and they can suffer damage. The low mass of all the parts results in a low physical inertia, so that any excess vibrations can affect the servos and linkages.

Make sure that your main and stab tubes are not damaged. Check that the front and rear anti-rotation pins for the wings and horizontal stabiliser are located correctly in their holes, and are not loose. Check that the 4 plastic wing retaining nuts are tight, that the M3 bolts retaining the horizontal stabilisers on to the aluminium tube are installed and tight, and that the hinge wires for the rudder and elevators cannot come out.

If you carefully checked all the points above and followed our advice exactly, you will have a safe and successful first flight - and many hours of pleasure with your Composite-ARF Extra 330SX.

## **General information about fully-composite aircraft structure and design**

All the parts are produced in negative molds, manufactured using vacuum-bagged sandwich construction technology. All parts are painted in the moulds, either single colour or designer colour schemes. A new production method, called TAVS (Total Area Vacuum Sandwich), enables us to present this aircraft with incredible built-in strength, while still being lightweight, and for a price that nobody could even consider some years ago. This production process has huge advantages, but a few disadvantages as well. These facts need to be explained in advance for your better understanding.

### **Description of Parts**

#### **The Wings:**

Both wing halves are made in negative moulds, fully vacuum-bagged, using only 2 layers of cloth in combination with a hard 2mm foam sandwich to form a hard and durable outer skin. Because of this TAVS technology no additional structural parts are needed except for the main spar tube.

The ailerons are already hinged for you. They are laminated in the wing mould and are attached to the main wing with a special nylon hinge-cloth, sandwiched between the outer skin and the foam. This nylon hinge is 100% safe and durable. You never have to worry about breaking it, or wearing it out. There is no gap at all on the top wing surface, and there is a very narrow slot in the bottom surface, where the aileron slides under the main wing skin during down throw. This hinge setup is the cleanest you can ever obtain, but you have to take some care during assembly for proper installation and servo set up.

First, the hinge line is on the top surface of the wing, not in the centre. This is NOT a disadvantage, if you set in about 10% NEGATIVE aileron differential in your transmitter program. This means that the 'down' throw needs to be about 10% more than the up throw.

Why? Because the axis of the hinge is not at the centreline of the aileron, so it moves slightly in and out when it travels, and the aileron gets a little "bigger" in surface area when moving up, and "smaller" when moving down. This is why you have to set the negative differential in your transmitter to compensate for the size changing. 10% is a good starting point, and you will find out the exact setting during the first flights, doing fast vertical rolls and watching the fuselage rolling in a perfect line. You can set it perfectly, this is guaranteed.

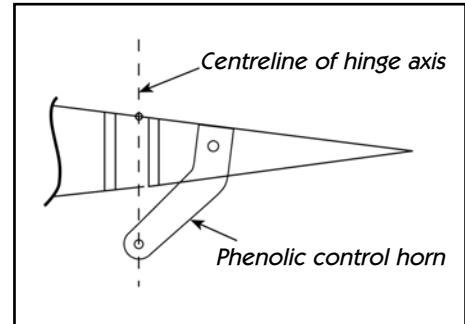

The bottom slot needs some explanation, too. The cut line is exactly in the correct position so that the aileron slides under the wing skin smoothly. If the cut was a few mm forward or back, it would not work properly. So, make sure that the lip is not damaged, and that the aileron slides under this lip perfectly. It will NOT lock at any time, as long as the lip is not damaged. If damage occurs to the lip, you can cut off 2-3 mm, but you should NEVER need to cut off more than this. Make sure that the control horns are glued into the ailerons properly. The hole in the phenolic horn for the quick-link needs to be exactly perpendicular to the hinge axis line, and in this manual we show you a simple way to ensure that the horns in all pairs of control surfaces will be identical, making it easy to set up your R/C for accurate flying manoeuvres.

The wings are already set-up with servo covers and hatches for 2 servos per aileron, and we recommend a pair of high-torque servos, like the JR D8411, in each wing. Our servo covers and milled plywood mounts make both installation, and exchange if necessary, very quick and easy and provide a rock solid servo mounting and linkage system.



The wings are attached to the fuselage with the 4 threaded aluminium dowel anti-rotation pins, with 4 plastic nuts inside the fuselage. If the aluminium dowels come loose in the wing, the wing will slide outwards, away from the fuselage, and the main spar tube will definitely break. So take great care to inspect the glue joints of these anti-rotation dowels in the wing REGULARLY. Excessive vibrations or hard shocks can cause the glue joints to weaken or break. Monitor these joints whenever you set up your plane. Never forget to tighten the nuts inside the fuselage. Please DO NOT modify these attachment dowels in any way, their perfect function is proven for many years.



### **The Fuselage:**

The fuselage is also made in negative moulds, and is all constructed using TAVS technology. All the loadbearing internal parts are installed during manufacture, to ensure accurate location and reduce your assembly time. The fibreglass tubes in the wings to receive the wing spar tube, the stab spar tubes, and the holes and reinforcement plates for the anti-rotation dowels, are already installed. There is no need to even check the incidences - you can be assured that these are already set in the moulds so that no adjustment is necessary.

The landing gear mount is strong and doesn't need any extra reinforcement. The fuselage is extremely light weight, and the gear loads need to be led into the structure gently. No glue joint needs to be stronger than the materials that it is attached to, as it would just result in increased weight for no advantage. The landing gear is a fairly flexible design, which works very much like

shock absorbers. This plane is not made for crashing, but the landing gear will take some hard landings without problems. Do not change or modify it, as the results would only be negative. We had plenty of time and experience to engineer the strength needed in this area - and we did !

The motordome and firewall are a fully integral parts of the fuselage, and provide plenty of strength for any engines up to 120cc on the market today. See the Engine Installation section for details of engine and setting thrust angles.

The engine cowling should be attached using the method shown. It is only a little work and this mounting has been tested and proven for many years.

**The Stabilisers:**

The stab parts are also vacuum bagged sandwiched. The rudder is hinged with a 2mmØ steel wire, and the elevator control surfaces are hinged with 4mmØ tubes, fitted through phenolic hinge bearing plates which are jig-installed during manufacture for perfect alignment.

The rudder and elevator design allows for at least 50 degrees throw. For the Extra it is mandatory that the tail area is extraordinarily light weight, so the stab is designed for one powerful servo installed in each half. All the structural parts are preinstalled. The horizontal stabs are mounted with one 20mm aluminum tube and one aluminium anti-rotation pin each.

**Servo Screws:**

Fix the *all* the servos into the milled plywood servo mounts using the 2.9 Ø x13mm sheet metal screws provided in the kit, **not** the standard screws normally supplied with servos by the servo manufacturer. This is because all the holes in our milled servo mounts are 2mm diameter, due to our CNC manufacturing process, and this is too big for the normal screws.

**Take Care:**

Composite sandwich parts are extremely strong, but fragile at the same time. Always keep in mind that these contest airplanes are designed for minimum weight and maximum strength in flight. Please take care of it, especially when it is being transported, to make sure that none of the critical parts and linkages are damaged. Always handle your airplane with great care, especially on the ground and during transport, so you will have many hours of pleasure with it.



*(above) The lightweight fin-post has the phenolic rudder hinge posts already installed and aligned at the factory. The corresponding tubes are also installed in the rudder for the hinge wire.*

*(below) The elevator hinging uses 4mm diameter aluminum tubes, inside phenolic hinge posts that are factory-installed and aligned.*



## Accessories

Below are the things you may need to get your Composite-ARF Extra 300SX in the air. Some of them are mandatory, some of them can be chosen by you. What we list here are highly recommended parts, and have been thoroughly tested.

1. Power servos (min. 8 required). We highly recommend JR 8411 or 8511/8611 for all control surfaces. For Futaba users, we recommend 2 x S9351's for each Aileron, 1 x S9351 for each elevator, and either 2 x S3951's or 2 x S9152's for rudder.
2. Aluminium servo output discs, or full metal arms (8 pieces). We strongly recommend that you attach the phenolic servo extension arms provided in the kit to metal servo output discs, or use full metal servo arms (eg: SWB 'Double-Loc' type)
3. Throttle servo. Any standard servo will do (eg: JR/Graupner 4041/5391)
4. Aluminum Spinner 120 - 125 mm/4.75 - 5" dia. eg: Tru-Turn. (Ø120mm carbon spinner & CNC T6 alu. backplate available from C-ARF as an option, #810100 - 810103)
5. Main wheels 115 - 125 mm (4.5 - 5"). Kavan Light or Dubro wheels are recommended.
6. Engine 75 - 100cc. The DA-100 is probably the most commonly used engine for our 2.6m span Extras. In these instructions we show the installation of this, and also a lightweight option with a 3W 80cc single cylinder and tuned pipe set-up.
7. Muffler/Canister or Tuned pipe(s) and headers. (Headers, canisters, tuned pipes and Teflon joiners are available from C-ARF as options. See our webpage for availability)
8. Tailwheel assembly. (Available as an option from C-ARF. Product # 801000.)
9. High quality heavy-duty servo extension cables, with gold connectors. High quality receiver and ignition switches, etc.
10. Receiver batteries.
11. Powerbox and dual powerswitches for dual batteries (available from C-ARF as an option)
12. Fuel tank (750 - 900 ml) with gasoline stopper. We use Dubro.
13. Cable ties in various lengths.
14. Propeller. Carbon Meijzlik or Menz 28 x10 for DA-100. 26 x 12 or 27 x 10 for 3-W 80cc.

## Tools

This is a very quick and easy plane to build, not requiring difficult techniques or special equipment, but even the building of Composite-ARF aircraft requires some suitable tools! You will probably have all these tools in your workshop anyway, but if not, they should be available in all good hobby shops, or hardware stores like "Home Depot" or similar.

1. Sharp knife (X-Acto or similar)
2. Allen key set (**metric**) 2.5mm, 3mm, 4mm & 5mm.
3. Sharp scissors
4. Pliers (various types)
5. Wrenches (**metric**)
6. Slotted and Phillips screwdrivers (various sizes)
7. M3 tapping tool (**metric**)
8. Drills of various sizes
9. Small spirit level, or incidence meter.
10. Dremel tool (or Proxxon, or similar) with cutting discs, sanding tools and mills.
11. Sandpaper (various grits), or Permagrit sanding tools (high quality).
12. Carpet, bubble wrap or soft cloth to cover your work bench (most important !)
13. Car wax polish (clear)
14. Paper masking tape
15. Denaturised alcohol, or similar (for cleaning joints before gluing)

## Adhesives and Solvents

Not all types of glues are suited to working with composite parts. Here is a selection of what we normally use, and what we can truly recommend. Please don't use inferior quality glues - you will end up with an inferior quality plane, that is not so strong or safe.

High performance models require good gluing techniques. We highly recommend that you use either a slow (minimum 30 minute cure) epoxy resin and milled fibre mixture, or a slow filled thixotropic epoxy for gluing highly stressed joints (eg: Hysol 9462). The self-mixing nozzles make it easy to apply exactly the required amount, in exactly the right place, and it will not run or flow onto places where you don't want it! It takes about 1 - 2 hours to start to harden so it also gives plenty of time for accurate assembly. Finally it gives a superb bond on all fibreglass and wood surfaces. Of course there are many similar glues available, and you can use your favourite type.

1. CA glue 'Thin' and 'Thick' types. We recommend ZAP, as this is very high quality.
2. ZAP-O or Plasti-ZAP, odourless, or ZAP canopy glue 560 (for clear canopy)
3. 30 minute epoxy (stressed joints must be glued with at least 30 min & NOT 5 min epoxy).
4. Loctite Hysol 9462 or equivalent (optional, but highly recommended)
5. Epoxy laminating resin (12 - 24 hr cure) with hardener.
6. Milled glass fibre, for adding to slow epoxy for stronger joints.
7. Micro-balloons, for adding to slow epoxy for lightweight filling.
8. Thread-locking compound (Loctite 243, ZAP Z-42, or equivalent)



We take great care during production at the factory to ensure that all joints are properly glued, but of course it is wise to check these yourself and re-glue any that might just have been missed.

When sanding areas on the inside of the composite sandwich parts to prepare the surface for gluing something onto it, do NOT sand through the layer of lightweight glasscloth on the inside foam sandwich. It is only necessary to rough up the surface, with 80/120 grit, and wipe off any dust with acetone or de-natured alcohol (or similar) before gluing to make a perfect joint. Of course, you should always prepare both parts to be joined before gluing for the highest quality joints. Don't use Acetone for cleaning external, painted, surfaces as you will damage the paint.



**Tip:** For cleaning small (uncured) glue spots or marks off the painted surfaces you can use old-fashioned liquid cigarette-lighter fuel, like 'Ronsonol' or equivalent. This does not damage the paint, as Acetone and many other solvents will, and this is what we use at the factory.

*TIP: Lighter fluid is excellent for cleaning small marks, uncured glue, or similar off the painted surface of the plane - without damaging the colour finish.*

At Composite-ARF we try our best to offer you a high quality kit, with outstanding value-for-money, and as complete as possible. However, if you feel that some additional or different hardware should be included, please feel free to let us know.

Email us: [feedback@composite-arf.com](mailto:feedback@composite-arf.com).

We know that even good things can be made better !

***Did you read the hints and warnings above and the instructions carefully?***

***Did you understand everything in this manual completely?***

***Then, and only then, let's start assembling your Composite-ARF Extra 300SX***

## Building Instructions

### General Tips:

We recommend that you follow the order of construction shown in this manual for the fuselage, as it makes access to everything easier and saves time in the end. The wings and stabs can be done at almost any point, and only need servos and control horns installing anyway.

The first thing to do is protect the finished paint on the outside of the model from scratches and dents during building - so cover your work table with a piece of soft carpet, cloth or bubble-plastic. The best way to stop small spots of glue getting stuck to the outside of the fuselage is to give the whole model 2 good coats of clear car wax first, *but* of course you must be sure to remove this 100% completely before adding any decals or markings. Additionally you can cover the majority of the fuselage with the bubble-plastic used to pack your model for shipping, fixed with paper masking tape, which also protects it very well.

When sanding any areas of the inside of the fuselage to prepare the surface for gluing something onto it, do NOT sand right through the layer of glasscloth on the inside foam sandwich ! It is only necessary to rough up the surface, with 60/80 grit or equivalent, and wipe off any dust with alcohol (or similar) before gluing to make a perfect joint.

Before starting construction it is a good idea to check inside the fuselage for any loose glass fibres that could cut your hands, and a quick scuff over any of these with a coarse Scotchbrite pad will remove them.

**Note:** It is very important to prepare the inside of the fuselage properly, by roughing up and cleaning the surface, before gluing *any* parts to it.

### Landing Gear

The 1st job is to fit the landing gear legs (wheel pants and cuffs can be done later) - and you can leave these in place to protect the bottom of the fuselage during assembly.

The Composite-ARF landing gear for the Extras consists of 45 deg laminated carbon fibre cloth and a huge number of carbon rovings inside, all made under vacuum and heat-cured. However it is still light weight, and retains enough flexibility to take the shock out of any landings that are less-than-perfect!

Mark the centreline on each carbon landing gear leg, and drill 2 holes with a sharp 6.5mm Ø drill as shown in the photo. The centres of the holes are measured from the bend in the leg that will be flush with the outside of the fuselage. The outer hole is 35mm from the bend, and the inner hole is 58mm (2 5/16") from the 1st hole. Both main legs are identical, and can be used either side.

The carbon landing gear legs are secured to the revised aircraft-grade plywood supports and bulkheads in the fuse-



(above) The main parts used to assemble the Landing Gear.

(below) Drill 2 x 6.5mm Ø holes for bolting in the Landing Gear.



lage (factory-installed), using the supplied M6 x 20mm bolts and washers into the pre-installed T-nuts. See photo P1.

Note that the bend on the underside of each landing gear leg should be flush with the outside surface of the fuselage skin, and therefore you may need to chamfer the bottom edges of the factory-cut slots in the fuselage a little with a file to make sure that there is no interference.

Sand the inside of the 'U-shape' molded in recesses in the wheelpant, and glue in the milled 3mm plywood U-shaped part as shown, using 30 min. epoxy. At the same time glue in a milled 20 x 20mm square plywood plate on the inside of the wheelpant, against the kevlar reinforcement, with the centre of the square about 6mm (1/4") behind the vertical centre from the axle position, and about 25mm (1") above it. This part is reinforcement for the M3 T-nut that will be installed later. (see photo P2)

Drill a 6mm Ø hole in the bottom of each carbon leg for the axle, through the small dimple that is molded-in to mark the correct position. Drill 6mm through the hole in the U-shaped ply part on each wheel pant. Drill an 9mm diameter hole in the outside of the both wheelpant, directly opposite the 6mm hole for the axle. This hole is for inserting the M6 x 70mm hardened bolt that is used as the axle.

Insert the bolt into the wheelpant through the 9mm hole, threading on the washers and wheel collars, used as spacers, as needed to centre the wheel in the pant. The last 2 items to go onto the axle are a plain M6 nut and a washer, which will be against the inner surface of the wheel pant. (see typical example below). Secure the axle onto the landing gear with a washer and M6 lock-nut on the inside of the carbon leg. During final assembly a drop of Loctite on the M6 lock-nut is good insurance.

Set the fuselage on a level surface with the tailwheel in place, and adjust the angle of the wheelpant so that they are parallel with each other, and will not touch the ground on takeoff or landing. Tighten the M6 stop-nut firmly, and tack glue the carbon leg to the plywood 'U-shape' with 1 small drop of CA to make sure it cannot move during the next step. Drill 3mm hole through the middle of the carbon leg, 25mm above the centre of the axle, into the small ply square inside the wheel pant, and fit an M3 x 16mm bolt and washer in place.

Remove the axle, wheel and spacers and



(above & below) Glue the milled plywood reinforcements to the inside & outside of the wheelpant as shown. The inside plate will have an M3 T-nut glued to it later.

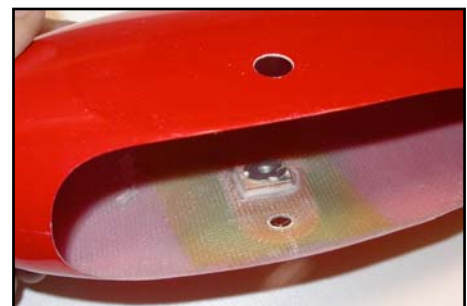

(above) The moulded dimple in the bottom of the carbon legs. Drill a central hole of 6mm diameter.

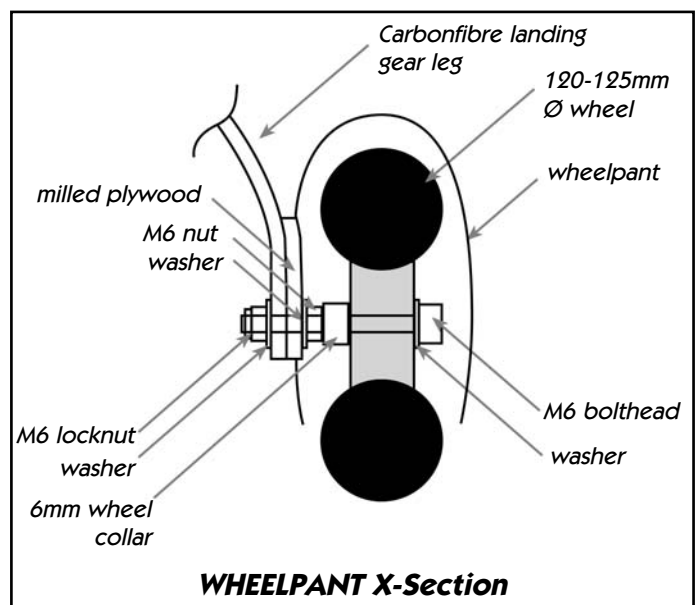

carbon leg. Redrill the hole in the wheelpant and plywood square only (not the carbon leg) to 4.5mm diameter, and glue an M3 T-nut to the plywood square inside the wheelpant for the M3 bolt. This bolt maintains the correct angle of the wheel pants to the ground. (see photo P3) Do *not* use a bolt larger than M3, as the larger diameter hole in the leg can weaken it.

The typical order of fitting the wheelcollars, washers and wheel onto the axle, to centre the wheel in the wheelpant, is shown in the diagram above - but of course it will vary slightly depending on the size and type of wheel used.

You can use any 4.5" - 5" main wheels. Kavan wheels are very lightweight, but not very durable on asphalt runways, and Dubro wheels are a little heavier but much more solid.

### Leg Cuffs

The Extra 300SX has fairings at the top of each LG leg where they enter the fuselage, and these are supplied in the kit as lightweight fibreglass mouldings. It is a little more difficult to remove the LG legs for replacement when the cuffs are in place, and we suggest that they are glued in place onto the fuselage with clear silicone adhesive (bath sealant), so they can easily be removed if necessary. Note that there is a 'right' and a 'left' leg cuff, but which is which will be very obvious when you trial fit them to the fuselage!

Mill the slot in each cuff for the carbon legs, leaving about 0.5mm (1/15") gap all around to allow for the flexing of the carbon leg during landing, and to make it easier to remove the carbon legs from the fuselage. Sand border of the cuffs smooth, and glue to fuselage with a little clear silicone adhesive.

### Tailwheel

The tail wheel setup shown in these photos is an optional part available from C-ARF (# 801000), and is mounted with 4 sheet metal screws and 2 plastic 'U' brackets under the fuselage, screwed into the plywood reinforcement that's installed in the fuselage at the factory.

You don't need to make the tailwheel steerable if flying from grass surfaces, a simple castoring action is fine. However, for hard runways you may prefer to connect it either to the rudder horn with 2 springs as shown, or even better to the rudder pull-pull cables about 250mm in front of the rudder leading edge - as shown here. It's easy to make the springs by winding some 0.8mm Ø piano wire around a 5mm drill bit, turned slowly in a battery-drill, with a small hook in each end to connect to the tailwheel steering arms. (see also photo P21)

Remember - keep it lightweight at the tail end!



*(above) Fibreglass leg Cuffs are secured to fuselage with a little clear silicone adhesive, allowing easy removal if necessary.*



*(above) Optional tailwheel assembly from Composite-ARF.*

*(below) Tailwheel assembly can be connected to rudder horn OR rudder cables with springs for improved steering.*



## Cowling

The 1 piece cowling is already cut and trimmed at the factory, and should need almost no adjustment for a perfect fit. With the main undercarriage legs bolted into place, install the wing tube in the fuselage sleeve and place a small spirit or incidence meter level on top of it to set the plane exactly level (side to side). Pack under one undercarriage leg as necessary to get it level on your building table.

If necessary, sand the fibreglass joining tapes inside the back edge of the cowl slightly to get a perfectly flush fit between the cowling and the fuselage sides. Trial fit the cowling, and use the spirit level or an incidence meter on the lower (flat) part of the cutout at the front of the cowl to make sure that it is level and properly centred. Tape the cowl firmly into position, and mark a centreline on the top of the cowl and the fuselage, on masking tape.

The cowling is held in place with 9 bolts (M3 x 12mm), washers and blind nuts. Drill one 3mm diameter hole at the top/centreline of the cowl, approx. 8mm (5/16") in front of the back edge of the cowling, and insert an M3 x 12mm bolt. Thread a T-nut onto the bolt inside the fuselage, and secure it to the fuselage with one small drop of thick CA.

Note that the blind nuts are fitted *reversed*, with the spikes pointing inwards! Check alignment again, and then drill and fit the other 8 bolts in the same way, securing the blind nuts to the inside of the fuselage with a single drop of thick CA. Space the 9 bolts 105mm (4.2") apart, so that the lowest 2 bolts will be quite close to the edges of the square cutout in the bottom of the cowling, which retains it properly.

Don't forget to wax, or oil, the M3 bolts first, to make sure that you don't accidentally glue any of the bolts to the cowling or into the blind nuts! Finally remove all the bolts and cowling, and glue the 9 blind nuts in place properly using a medium-thick mixture of 30 minute epoxy and micro-balloons, as shown. During final assembly, add the supplied M3 washers under the heads of all the M3 bolts.



(above) Cowling is secured with nine M3 bolts, into T-nuts fitted in reverse, glued inside fuselage with a thick micro-balloons mixture.

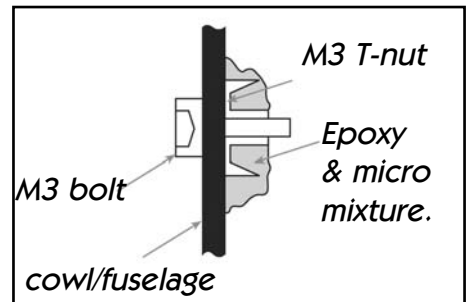

(above & below) Tack glue the T-nuts in position with a small drop of thick CA first. When cowling is correct, secure all the T-nuts with a drop of, fairly wet, epoxy and microballoons mixture as shown.



## Canopy Frame

The fibreglass canopy frame mountings are already completed for you at the factory. It is secured to the fuselage with four M4 x 12mm allen bolts, fitted from the outside of the fuselage, through the plywood tabs that are glued to the canopy frame, into M4 T-nuts. This system has been very well proven on all of our aerobatic planes, and is a strong rattle-free solution.

Fitting the clear canopy into the frame can be a little bit tricky, but this is a step by step guide of how we do it:

Sand the inside edges of the canopy frame carefully with 120 grit sandpaper, especially the fibreglass joining tapes, to ensure a perfect fit of the canopy. Fit the canopy frame on the fuselage and secure with all 4 bolts. Lay the canopy on top of the frame, view from the front to check that it is centred and symmetrically positioned, and then mark the approx. shape with a felt pen or wax crayon. Cut the outer border of the clear canopy with sharp scissors, about 12mm (1/2") too big all around. Unless you are in a very warm room, we recommend that the canopy is slightly warmed up with a hair dryer to prevent cracking - but be careful not to melt or deform it! When the canopy fits inside the frame, tape it into position temporarily, and accurately mark the edge of the frame on the canopy with a wax crayon. Remove the canopy and trim exactly to shape, leaving about 6mm overlap outside the line all around.

Refit the canopy into the frame, and tape into position from the inside. Push the canopy up tightly inside the back of the frame and fix the bottom 2 back corners with one small drop of odorless CA each (ZAP-O recommended).

**Note:** Do NOT use any CA accelerator/kicker - you will immediately 'fog' the clear canopy!

Make visual check from the front and back to make sure sure that the canopy is straight. Make several hand-holds with strong tape (see photo) to make holding and positioning the canopy easy. Remount the canopy frame to the fuselage (use all 4 bolts), and tape the canopy frame tightly to the fuselage all around. Using the tape handles to pull the canopy outwards firmly against the frame, working from the back towards the front, glue the edges of the canopy in place in 2 more places each side, with just a single small drop of CA at each position, all the time checking that the edge of the canopy is tight up against the frame at the front.

Now that the canopy is fixed in position and cannot twist or warp anymore, you can carefully remove the canopy frame from the fuselage, and use a 30 minute or 24hr epoxy and micro-balloon mixture for gluing all the edges to the frame on the inside surface (see photo above). It is most important that the canopy cannot come off in flight, so make sure that the bead of glue traps the clear canopy firmly in place. Re-secure the canopy frame onto the fuselage with all 4 bolts



*(above) The canopy frame is secured to the fuselage with 4 tabs, M4 bolts and T-nuts, all finished at the factory for you.*



*(above) Use duct-tape handles to pull the clear canopy tightly against the canopy frame while gluing it in position with a few very small drops of odorless-CA.*

*(below) When fixed, remove frame & secure edges of canopy firmly with epoxy/micro-balloon mixture*



while the epoxy-microballoons mixture is curing to prevent any warps or twists.

If you wish you can tint the inside of the canopy using one of the aerosol spray paints used for painting the inside of polycarbonate car bodies (eg: the Tamiya or Lexanit ranges). Use many very light 'mist' coats to get even coverage.

## Horizontal Stabs

The stabilisers are 95% finished at the factory, and only need the servos, horns and linkages installing. Insert the 20mm aluminium tube spar in the fuselage sleeve, and slide on both stabs to check the fit between the root ribs and the fuselage. You can sand the root of the stabs slightly to make a perfect joint if needed, and if the spar tube is a fraction long you must shorten it.

The elevators are hinged to each stab using the 4mm Ø aluminium tubes provided. Make sure there is no burr on either end of the tubes, and chamfer the ends slightly with fine sandpaper to make it easier to get them through the holes in the phenolic hinge plates. Be careful inserting them, and if they are a bit stiff, then use a little grease on the tubes. Don't use too much force, otherwise a phenolic hinge post inside might break loose. Leave the tubes a bit too long during assembly, and cut them to exact length when the model is finished. During final assembly, retain both ends of the tubes with small pieces of clear tape on the root and tip ends of the elevators.

## Servos

You have a choice of elevator servos; either a hi-power digital JR8511/8611 in each stab, or an JR8411, which is also sufficient. Although the JR8511/8611 servos are about 1 mm longer and wider than the 8411, both sizes will fit in the milled servo cutouts in the ribs. If using Futaba servos, we recommend that you use S9351's, which also fit the milled servo cutouts in the ribs. Please do not use inferior quality servos, or servo arms, in this plane. It will result in an aircraft that does not fly accurately, reliably or safely.

The servos are installed with the output shafts towards the stab trailing edge, and they must be installed using the 2.9mm Ø x 13mm sheetmetal screws provided in the kit, *not* the standard screws provided with the servos which are too small for the Ø 2mm milled holes.

## Servo arms

To obtain sufficient elevator throws, quite long servo output arms are needed (30 - 35mm/1.25 -1.5"). In the kit we supply phenolic servo arm extensions for this purpose, which can be fitted onto your servo output discs to achieve the throws. However, it is **mandatory** to secure these to metal servo output discs, or to use full metal servo arms (like those shown below from SWB) - and **not** the standard plastic output discs supplied with the servos. The extreme torque of the current hi-torque digital servos can strip the plastic splines from the inside of the disc - which will result in immediate flutter and destruction of your Extra. Several

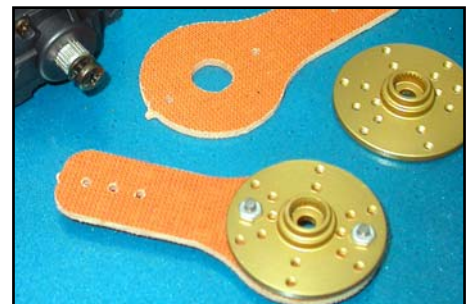

(above) If you use the phenolic servo arm extensions, you **MUST** bolt these to metal servo discs.

(below) The alternative is full metal servo arms, such as these SWB 'Double-Loc' types that we use on most of our factory planes.



reputable accessory companies make aluminium discs and servo arms, but you should check that the CNC machined splines fit onto the servo output shaft tightly, with a minimum of lost movement/play.

Secure the phenolic arms to the servo output discs as follows: Fit the metal discs to the servos. Centre both elevator servos using your R/C and attach the phenolic servo arms to the outside of the metal discs temporarily with a couple of drops of CA, making sure that the servo arms are both at 90° to the bottom surface of the stabs using a set square. Then remove the arms and discs, drill through both, and secure with at least 2 small bolts, washers, lock-nuts and Loctite (M2, 2/56 or equivalent). Finally add a drop of Loctite to the bolt that secures the discs to the servos.

✳ *Use this same method to attach the phenolic extension arms to metal discs for the aileron & rudder surfaces also.*

At Composite-ARF we only use the aluminium 'Double-Loc' servo arms from SWB manufacturing (USA) and we highly recommend them. These arms clamp onto the servo output shaft with no lost movement (play) at all. These are high quality, properly engineered arms, and are available from many good hobby stores.

With your chosen servo arm secured to the servos, fit them in place in the milled cutouts in the stabs and secure with the 2.9 Ø x 13mm sheetmetal screws we provide.

It is **most important** that the linkage from the servo arms is exactly in-line with the phenolic control surface horns in the elevators, as any 'side-load' or 'twisting' could weaken or even break them, causing flutter and destruction of your Extra. If you have chosen to fit full metal servo arms, (eg: SWB), you can fit a single-sided ball-link onto the servo arm to adjust the line of the linkage if necessary - but you **must not** fit a ball-link to a phenolic or plastic servo extension arm, or phenolic control surface horn.

If your chosen servo arm system does not line up perfectly with the factory-milled slots for the phenolic control horns, you can either fill the slots and mill new ones - or even pack the servo off the rib slightly inside the stabiliser to adjust the alignment. Make up the elevator linkages from the hardware supplied, using M3 x 45mm threaded rods, and M3 steel clevises and nuts at both ends. If you use a full metal servo arm, then you may need to use a wider clevis with a separate pin and E-clip, because of the thickness of the arm and the sizes of the holes - as shown on the SWB arms here. This also applies to the aileron horns, of course.

## Control Horns

The slots for the phenolic elevator control horns are already partly milled in the elevators for you, but may be adjusted or repositioned if required. Extend the slot for the elevator horn to least 20mm deep, using a Dremel mill or small Permagrafit file, checking alignment with the linkage as you work. Trim the length of one of the phenolic control arms so that the hole for the clevis is

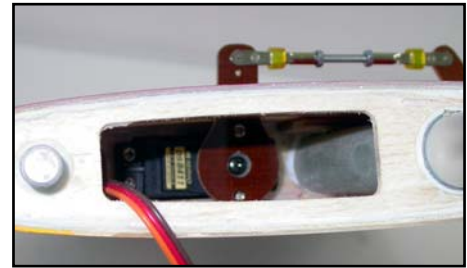

(above) Phenolic servo arm extension bolted to metal disc on servo. Short lengths of tube prevent clevises from opening accidentally.

(below) The alternative full-metal SWB servo arm set-up.

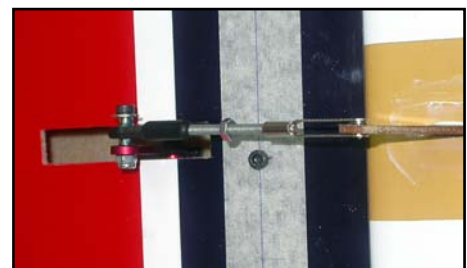
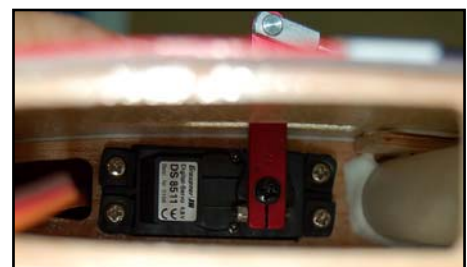

(above) You can **ONLY** use a ball-link on a full metal servo arm to adjust linkage alignment. Do **NOT** use on phenolic arms or horns



approx. 25mm from the surface of the elevator, and rough-sand the part that will be glued into the balsa block inside the elevator. Ideally the hole in the horn for the clevis should be exactly perpendicular to the centre of the hinge tube.

Wax the area with clear car wax, cover with a layer of plastic parcel tape over the area of the milled slot, re-wax the tape carefully, and then cut through the tape with a very sharp knife to allow the horn to be glued into the slots. The tape stops excess glue getting on the painted elevator, and makes the clean-up easy and quick.

Make up the servo linkage from the hardware provided, and connect your servo arm to the control horn, which helps to hold the horn in exactly the correct position while the glue cures. Fill the slot in the elevator with slow epoxy and micro-balloons (min. 30 minute cure), or a thixotropic resin like Loctite Hysol 9462, insert the horn, and then wipe away excess glue. Check that it is aligned perfectly with the linkage, the clevis hole is 25mm from the surface of the elevator, and is perpendicular to the hinge axis. View from the back or front to check that the horn is at 90 degrees to the surface of the elevator. See photo P6 for ideal linkage.

When cured, remove the plastic parcel tape and make a plywood template, as shown right, so that you can copy the position to the horn on the other elevator. In this way you will get exactly equal elevator throws without lots of mixing and linkage adjustment when setting up your plane. You can make the template from scrap plywood, and use an old 1.5mm (1/16") drill bit to insert into the clevis hole, secured with a drop of CA. Using the template, glue the horn into the other elevator in exactly the same way.

The linkages between the servo arms and elevator horns are made from the 45mm x M3 all-thread, with 2 steel clevises and 2 x M3 nuts for each stab. 'Loctite' the quick-link and lock-nut on one end of each linkage. If using full metal arms, like the SWB arms shown, you will need to replace the steel clevis on the servo end with a larger type as shown here. If using clevises with aluminium pins in aluminum servo arms, we highly recommend that you apply a little grease on these joints to give smooth movement and prevent any inclination of the aluminium pin to bind in the servo arm hole.

\* Use this same technique, as above, with a template, for the inner/outer aileron horns.

## Throws

If you need more travel on the elevators than the factory assembly allows (about 40°) you will need to increase the length of the slots in the composite/balsa false leading edge of the elevators with a small file. The outer 2 slots in particular will need to be longer, and you can extend them almost right out to the composite skin.

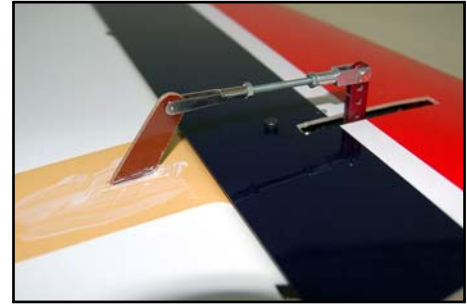

(above) Use parcel tape to protect paint & make easy clean-up when gluing in all control surface horns.



(above) Shows the stab retaining bolt, with clear tape over it to prevent it coming out in flight. The small pieces of tubing stop the quick-links from opening.

(below) Elevator horn alignment template from scrap plywood. Line is hinge axis. Use for both elevators to ensure same throws.



Unfortunately it's not possible for us to mill these slots longer during manufacture - as the L.E. spar would fall apart on the CNC milling table. However, this is a very quick job with a Permagrafit file, or similar (see photo right). You can easily achieve 50 degree throws if you wish.

**Note:** Several photos of the stabs in these instructions show the 1.5" SWB arms on JR8511 servos, with the clevis in the outer hole - and this was used for extreme testing of the model and stabiliser servo system, with more than 50 degrees throw possible.

### Static Balance

We advise that you partially static-balance the elevators by gluing 15 - 30 grams (0.5 - 1 ounce) of lead inside the mass-balance area in each elevator half, which helps to prevent any chance of flutter that could destroy your Extra.

How much you can add depends on your motor weight, but even adding 20 grams (0.7 ounce) will increase the safety factor. With a DA-100 you can definitely afford to add 30 grams to each elevator. Just drill a small hole in the inner leading edge of each counterbalance, and glue some strips of lead in with epoxy & micro-balloons mixture. Cover the hole with a sticker.

### Stab Tube

The last job is to fit the M3 stab retaining bolts. Inside the stabs you will see the small ply reinforcement plates between the spar sleeve and the bottom surface of the stab. Mark the bottom of both stabs in the centre of this plywood. Install the aluminium tube into 1 stab, and drill a 2.4mm hole right through the stab surface, the plywood plate, sleeve and the 20mm aluminium tube. The centre of the hole will be 33 - 34mm from the T.E. Thread the hole with an M3 tap and secure it with an M3 x 16 bolt. To be really safe, you can glue an M3 blind nut (included) inside the spar tube, with some 30 minute epoxy and micro-balloons. Wax or oil the bolt first! Fit both stabs to the fuselage, check that they fit tightly to the fuselage at the roots, and then drill the hole in the other stab and spar tube, and tap the thread as before. Counterbore the holes in the bottom surface of the stabs for the boltheads so that they sit flush on the small plywood plates.

**TIP:** Try to always leave the stab tube fixed into one stab, and never remove that one bolt, as it is difficult to find the right position for the stab tube again if it is removed from both stabs!



*(above/below) You can increase available throws by lengthening the slots in the leading edge of the elevators, especially the 2 outer slots. Use a fine flat file, such as a Permagrafit, and be careful not to make the slots any wider.*



*(above) Glue 15 - 30 grams lead into the leading edge of the elevator mass-balance to help prevent any chance of flutter.*

*(below) M3 blind nut glued into elevator spar tube.*



## Rudder

Trial fit the the double-sided phenolic control horn in the slot that is already milled in the base of the rudder, mark the central part that will be glued in, and scuff it well with coarse sandpaper. There is a balsa block underneath the horn position inside the rudder, and this should also be scuffed with sandpaper or a small file. Adjust the milled slot in the rudder so that it is a little higher than the phenolic control horn thickness, so that all the glue is not scraped off the horn when you insert it into the rudder !

Cover the rudder both sides around the slot area with masking tape, wax the area, and then cut through the tape to expose the slot with a sharp knife - in the same way as described for the elevators. This makes it easy to clean off excess glue afterwards. Glue the horn in position with slow (min.30 minute) epoxy & micro-balloon mix, making sure that it is perfectly centred and level in the rudder. When the glue has cured, fit the rudder to the vertical stabiliser with the 2mm steel hinge wire. Sand a small chamfer on the end of the hinge wire for easier insertion through the phenolic hinge posts, and if it is too tight use a little grease on the wire. Check for smooth movement. You can increase the lengths of the slots in the rudder L.E. in same way as the elevators to gain extra throw if necessary.

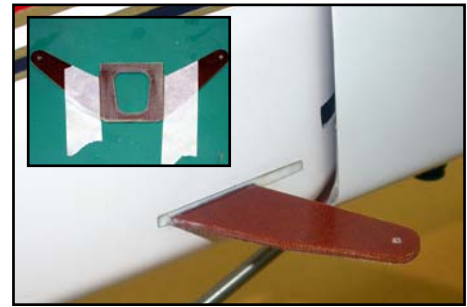

*(above) Scuff up the gluing surfaces on the rudder horn and glue into the slot in the rudder.*

*(below) The Tank base/Rudder tray is assembled from the milled parts included in the kit.*

The rudder servo mounting plate (and tank base) should be installed in the plane *after* the engine and exhaust system mounting are completed, but it is easier to assemble the parts and install the servos outside the model now.

Glue the 2 milled plywood reinforcing pieces underneath the servo cutouts in the balsa plate with CA, and glue the plywood reinforcement onto the underside of the tank tray (see also photo P8). Prepare, sand and assemble the other milled composite balsa parts as shown above, using thin CA. Check fit of the complete assembly in fuselage, and then apply a fillet of 30 minute epoxy to all joints and edges. It's a good idea to seal all bare edges of the fuel tank base with a coat of laminating epoxy now, or even thin CA, in case of fuel leaks. Adjust the height of the vertical balsa bulkhead between the tank base and servo tray, if necessary, so that the tank sits level when the plane is in level flight. The angled balsa plate behind the rudder tray is optional, and can be used for locating your Powerbox or Receiver if you wish. (photo P9)

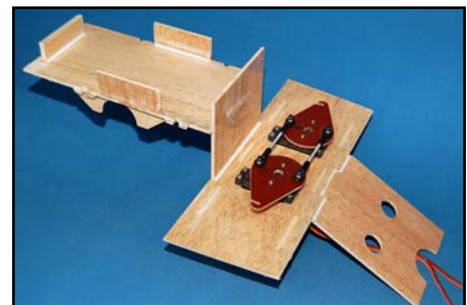

## Servos

The recommended choice of servos is similar to that for the elevators, either a pair of JR/Graupner 8411/8511/8611's or a pair of Futaba S9351's.

## Servo arms

The supplied 'pear-shaped' phenolic rudder servo output horns **must** be bolted to 1" or 1.25" diameter metal servo output discs in the same way as the elevators. Please do **not** use the standard plastic discs for this, as there is a chance that the internal plastic splines can be stripped by the current hi-torque servos - causing instant rudder flutter, and probable loss of your plane. Fit the 2 rudder servos into the tray, with the output shafts nearest to the tailplane, and screw into position using the 2.9mm Ø x 13mm long sheet-metal screws supplied. Fit the metal servo

discs, and centre both servos using your R/C. Rough sand and clean the bottom surface of the 2 phenolic horns, and the top of the metal discs.

With the R/C still switched 'ON' place the C-ARF rudder servo horns on top of the output discs, with both 'hooks' facing forwards, and align them exactly using a steel ruler as shown in the photo above. Make sure that the back of the hook slots and the output disc securing screws are all perfectly in line. Tack glue the phenolic arms on top of the output discs with a couple of drops of thick CA. When the glue has cured, remove the arms and discs, drill through both and secure with at least 2 small bolts, washers, lock-nuts and Loctite (M2, 2/56 or equivalent). Finally add a drop of Loctite to the bolts that secure the discs to the servos.

Make up the linkages between the servos from the M3 ball-links and threaded rod included, as shown. Secure *just one* of the linkages between the phenolic arms, with the M3 x 16 bolts through the milled holes, with lock-nuts underneath. Adjust the length of the linkage very carefully until so that there is minimal buzzing or humming from the servos at idle, or at full throw. When satisfied, add the other linkage and follow the same method of adjustment. (photo P9)

After the motor and exhaust system is finished, glue the competed tank base/rudder servo tray into the fuselage with 30 minute epoxy and micro-balloons mixture. Make sure to get a good glue joint between the supports on the bottom of the tank base and the wing tube sleeve. Install the wings on the fuselage during this operation, to make sure you cannot deform the fuselage. Scuff up the fuselage where the parts will be glued in, and reinforce these important joints with short lengths of the 1" fibreglass tape supplied, using laminating epoxy. (photo P10)

With the rudder servos fitted in the recommended position, then the centre of the slots that you must cut for the parallel pull-pull cables to the rudder is 475mm (18 3/4") forward of the back edge of vertical fin, and 53mm (2 1/8") up from the bottom of the fuselage. Cut out a small slot first with a very sharp knife, check the position using the pull-pull wire, and then adjust and open up the slots with a small file as needed. The slots need to be about 3mm high and 50mm long. If you prefer to 'cross' your rudder cables, then these slots should be 175mm forward of the fin TE, and approx. 33mm above the bottom of the fuselage.

Make the pull-pull wires from the hardware supplied, with a loop at the front that goes over the hooks on the output arms, and a quick-link with threaded extender (turnbuckle) and locknut at the rudder end. Pass the closed loop cable through the supplied 'crimping tubes' 2 times before squashing flat with pliers (see photo). Make sure that the wires are tight, and check and adjust after the first few flights as the cables straighten out. Even a small amount of slop will prevent your Extra from perfect tracking. You can glue a very small scrap of ply or balsa across the front of the slots on the servo arms with a drop of CA to prevent the wires coming out of the slots accidentally.

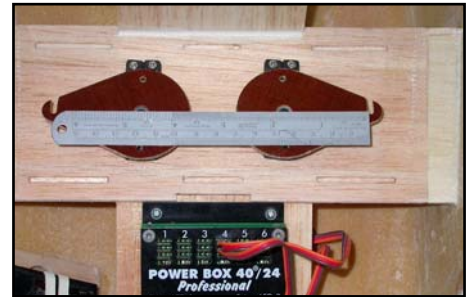

(above) Centre the servos with your TX & align the horns very carefully with a steel straight edge.

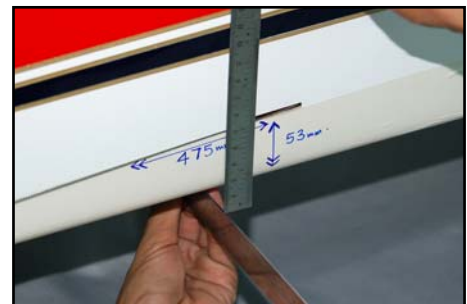

(above) Slot positions for parallel rudder cables.

(below) Pass rudder cable thru' crimping tubes 2 times for safety, and prevent all clevises from opening with small pieces of tubing.



## Wings

The wings are 95% finished at the factory, and have already been installed on your fuselage to set the alignment. Slide the wings onto the wing tube and check for a perfect fit. You can sand the wing roots a little if needed.

Fit the 4 plastic wing retaining nuts onto the M6 threaded aluminium wing dowels. We have already installed plywood reinforcement rings inside the fuselage for the back nuts, but you need to glue on the 2 small rings of milled 3mm plywood for the front nuts, parallel to the back surface of the plastic nuts. Sand a chamfer the plywood rings so that they are only 0.5mm thick at the bottom edge. Use 30 min epoxy and micro-balloons to glue in place, and fit the front nuts loosely while curing to set the alignment. Fill the gap between the top of the rings and the plywood plates on the fuselage side with epoxy/micro mixture. Don't forget to wax or oil the front dowels and M6 threads first to prevent them being glued in permanently!



(above) Plywood rings glued in vertically for front nuts with thick mixture of epoxy/micro-balloons.

Each wing has 2 servos for each aileron, and the openings for the servos and hatches are already pre-cut in the wing for you, and supplied with matching servo covers and milled plywood servo mounts (photo P11). Sand the inside surface of the servo hatch covers very well, and the milled plywood parts that make up the servo mounts to make sure you have a good gluing surface. This is very important! We highly recommend that you mark the 4 hatch covers now so that they are always fitted in the correct positions (eg: Starboard Inner/Outer etc).

## Wing Tube

The wing tube is a 40mmØ T6 alloy tube, which slides inside a fibreglass tube in each wing, and it should be 1040mm long. Please check the length to make sure that it passes through *both* plywood ribs in the wing, that are about 350mm from the root, otherwise the wing could fail in flight.

**Important:** Due to manufacturing tolerances on some early kits it is possible that the fibreglass tubes are a little bit long, or the wing tubes a little bit short, allowing the wing tube to slide into one wing further than the other - and then the alloy tube will not pass thru the both plywood ribs. In this case, you *must* glue a 10mm thick scrap balsa block into the outer end of both fibreglass tubes to make sure that the wing tube stays centred, and both ends pass thru' the plywood ribs.

## Servos

The choice of servos is similar to that for the elevators, a pair of JR/Graupner 8411/8511/8611's or a pair of Futaba S9351's in each wing. If using 8511/8611 servos you will need to sand the inside of the plywood servo mounts about 0.5mm bigger all round for a good fit.

Install the servos with the output shafts towards the leading edge. The ailerons have enough torsional flexibility to prevent servo damage if each pair is not perfectly matched.

## Servo arms

To obtain the maximum possible aileron throws quite long servo output arms are needed (30 - 35mm/1.25 - 1.5"). In the kit we supply phenolic servo arm extensions for this purpose, which can be fitted onto your servo output discs to achieve the throws. However, it is **mandatory** to secure

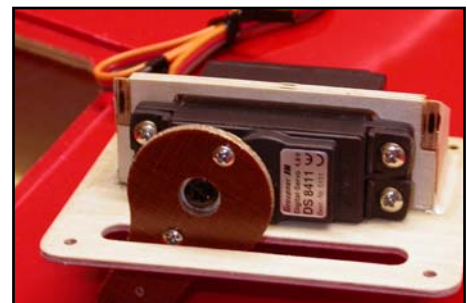

(above) Phenolic servo arm extensions may only be fixed to metal servo output discs.

these to metal servo output discs, or to use full metal servo arms (like those shown here from SWB) - and **not** the standard plastic output discs supplied with the servos. Secure the phenolic servo arm extensions to the metal output discs in the same manner as used for the elevators, centering the servos with the R/C and making sure that all 4 arms are all at exactly 90° to the side surface of the servos.

Assemble the servo mounts from the 3 CNC milled plywood parts supplied for each servo, using thin CA, as shown in the photos here, and P12. Fix the servos into the mounts with the 2.9mm Ø screws provided in the kit, and secure your chosen type of servo output arm to the servos.

Place the servos in their mounts on the inverted hatch covers to check the alignment so that the servo output arms are exactly in-line with the pre-milled slots in the wing for the control surface horns. The same principles apply here as for the elevators, and you can adjust the slots in the ailerons, or the slots in the hatch covers slightly, if necessary, depending on your servo arm type. Tack the mounts in place onto the hatch covers with a drop of thin CA.

When satisfied, glue the servo mounts to the hatch covers permanently, with thin CA, and then remove the servos, and reinforce the glue joints between the servo mount and the servo cover plate with slow (at least 30 minute) epoxy and milled fibre, with a nice glue fillet all around. These are important glue joints!

Each servo hatch is fixed to the underside of the wing with of the 4 sheet-metal screws provided, Ø2.9 x 10mm. These servo mounts allow you to change a servo within a few minutes, if needed, easily within the time between 2 flying rounds of a contest.

### Control Horns

The slots for all 4 phenolic control horns are already partly milled in the ailerons for you, but may be adjusted if required. Extend the slots for the horns to least 20mm deep, using a Dremel mill or small Permagrafit file, checking alignment with the linkage as you work.

Fit *just one* inner control surface horn to start with, using the same method as described for the elevators. Trim the length of one of the phenolic control arms so that the hole for the clevis is approx. 23mm from the surface of the aileron, and rough-sand the part that will be glued into the balsa block inside the aileron. Ideally the hole in the horn for the clevis should be exactly perpendicular to the centre of the hinge axis on the top of the wing.

Use a layer of parcel tape and clear wax to protect the aileron surface. Install the corresponding servo and hatch,

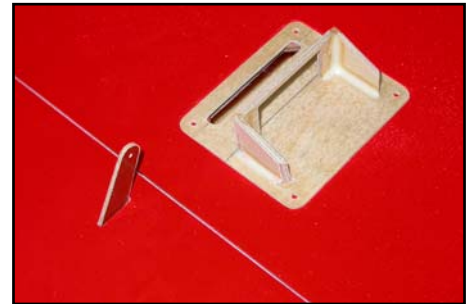

*(above) Adjust position of servo mounts on hatch covers so that servo output arms align exactly with phenolic aileron horns.*



*(above) Clevis hole for inboard horns should be 23 - 24mm from aileron surface, and perpendicular to the aileron front edge.*

*(below) Make sure control horns are perpendicular to aileron surface and parallel to servo arm.*



*(below) View of aileron linkage, with servo using metal disc, C-ARF phenolic extension arm and the included hardware.*



make up the linkage from the M3 clevises, 45mm long threaded rod and nuts provided - and connect the linkage from the servo arm to the control surface horn while the glue is curing to help maintain perfect alignment. When cured, remove the plastic parcel tape and make a plywood template, as shown right, so that you can copy the position for gluing in the inboard horn on the other aileron.



(above) *The aileron horn template used to position the inner horns for gluing in place. The line is perpendicular to the hinge axis.*

The 2 outer control surface horns are completed using the same method, first finishing one, and then using a template to glue in the other one. However, the distance between the clevis holes in the phenolic horns to the hinge axis line (top surface of the wing) should be the same for the inner and outer horns. However, because the wing/aileron is 6mm (1/4") thinner at the position of the outer horns, these outer horns must project of the aileron 6mm more than the inner horns. This is to ensure that the aileron servo throws are similar and that the servos don't 'fight' against each other.

(below) *Same template, with an extra hole drilled exactly 6mm higher, for installing outer horns.*

Because of the difference between the inner and outer horns, the easiest method is to make the template for the inner horns and glue them both in place first, and then drill another hole in the same template 6mm higher, exactly on a line drawn on the template that is perpendicular to the hinge axis - and use this for the outer horns.

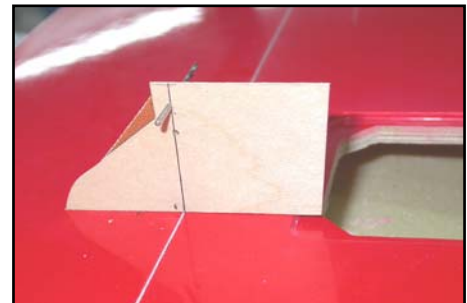

**Note:** There are a few early slightly different versions of the 300SX wings which do not have a balsa sub-rib outboard of the outer aileron servo position. Although this rib is not structurally necessary, if your wings do not have this rib it is a good idea to glue a 70mm (3") long piece of 3mm balsa immediately outside the servo cutout between the top and bottom wing skins to prevent damage to the wing in the case of flutter.

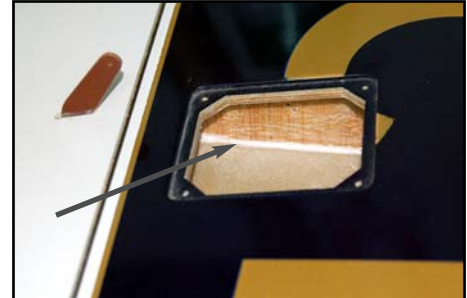

Sand the inside surfaces of the wing, cut a piece of scrap 3mm balsa, with the *grain vertically*, and glue inside the wing with 30 minute epoxy and micro-balloons mixture against the edge of the plywood hatch reinforcement. This part is shown with an 'arrow' in the photo right.

## Engine and Exhaust Installation

We strongly advise you to complete the motor and exhaust installation before the fuel tank base and rudder servo tray are permanently installed, as it provides much easier access.

The most commonly installed motor in our 2.6m Extras seems to be the DA-100, very often with a pair of MTW TD75k canisters - and we have shown photos of the installation of this popular set-up below. However, please note that all of those photos show the installation in one of our original 2.6m Extra 330L's (Futaba scheme), but it is almost identical - so please don't get confused !

For the 300SX prototype we chose to use a single-cylinder 3W 80cc Xi, and single 'Greve' tuned pipe set-up, to show a lightweight and lower cost option. This has proved to be a very nice com-

bination, having plenty of power - and a weight reduction of about 800 grams over the DA-100 version. Full details of this installation are also described below. All photos of the 3W motor are shown mounted on the 300SX (Patty Wagstaff scheme). Any similar 75 - 85cc single-cylinder motor could also be used, for example the ZDZ 80 or the EVO80.

The only major engine mounting difference between the 300SX and the 330L is that the firewall on the 300SX is approx. 30mm further back from the front of the cowl, to allow for longer motors, and that the complete motor-dome is an integral part of the fuselage molding - which saves weight, increases rigidity and ensures that the alignment of the firewall is more accurate.

The front face of the molded motor-dome/firewall on the 300SX is set at 0 degrees downthrust, and has 2.5 degrees of sidethrust built in to it. Therefore you only need to secure your motor parallel to the firewall, and so that the spinner is central with the cowling, and your thrustlines will automatically be very close to optimum. At most you will need to add a couple of washers behind the motor standoffs to have a perfect thrustline set-up.

Whichever motor you are using the vertical location of the centre of the motor on the firewall can be set as follows: Lay a steel straight-edge on top of of the fuselage (on the joint seam) as shown in photo P13. The offset between the radiused part at the front top of the cowl and the straight edge is 20mm (photo right). The top of the spinner should be about 5mm below the top of radiused part of the top of the cowl. Therefore, if you are using a 120mm (4.75") diameter spinner the horizontal centreline that the engine should be mounted on is 85mm (half of 120 + 5 + 20mm) below this straight-edge. Of course, if your spinner is  $\varnothing$  125mm, then this centreline will be 2.5mm lower, etc., pro-rata. Mark the horizontal centreline (for your choice of spinner diameter) on tape on the front of the firewall now, making sure that the line is horizontal by eyeing thru' the steel ruler and the wing tube.

The side-to-side location of the centre of your motor is also easily set. It is 8mm to the (pilots) left of the central seam of the motor-dome. (see photo right). With the motor mounted centred on these 2 lines, with 4 equal length standoffs, the centre of the spinner will be centred on the front of the cowling.

### **3W 80cc Xi.**

For this set-up we used a C-ARF 120mm diameter carbon spinner (# 810103), a Greve tuned pipe (# 910200), with a custom welded manifold and a Mejzlik 27 x 10 carbon 2-blade prop.

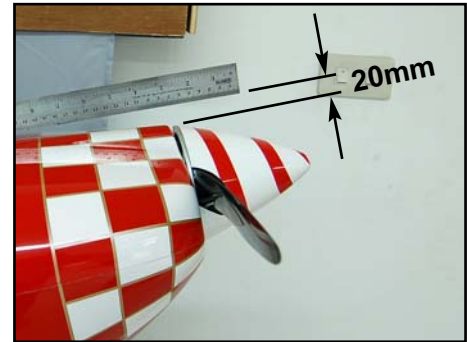

(above) The top of the spinner should be 5mm below the radiused front edge of the cowl, which is 20mm below the straight edge laid flat on the fuselage.

(below) The side-to-side centre of the motor should be 8mm to the pilots left of the motordome seam. The cutout shown here is for the rear-mounted 3W carburettor.

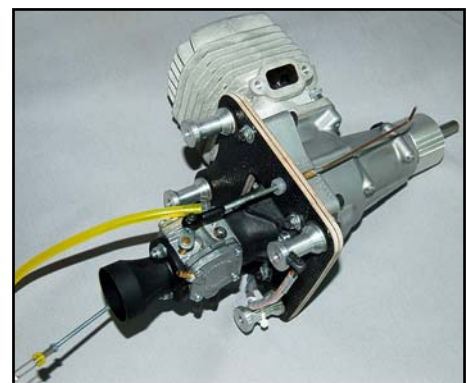
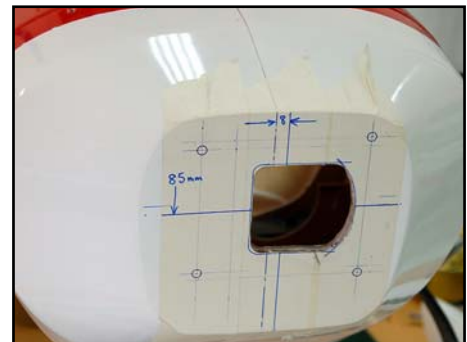

(above) The 3W 80cc Xi motor, attached to 6mm carbon/plywood plate, with 30mm long aluminum stand-offs - also showing throttle and choke linkages.



3W state in their instructions that the engine must not be mounted directly to metal stand-offs, as unequal lengths, or unequal tightening of the bolts could cause crankcase distortion. Therefore we made a mounting plate from 2 layers of 3mm carbon-composite plywood, glued together with 24hr laminating epoxy, and bolted the engine to this with M5 bolts, washers and lock-nuts. Then the carbon-ply mounting plate was secured to the firewall using 4 stand-offs of exactly 30mm length, with the M6 bolts and washers included in the hardware.

As it is a single-cylinder engine we chose to use anti-vibration mounts in the carbon-plywood mounting plate, made from the usual 'well-nuts' (or short lengths of hard silicone or rubber tube) to isolate the mount from the firewall, and it certainly does help to prevent transmission of vibrations to the airframe.

Four 9.5mm diameter holes were drilled in the carbon plate for the M6 bolts, and the well-nuts were inserted from the front face, with the excess length trimmed flush with the back surface. The M6 bolts should be a fairly tight fit inside the well-nuts or tubes used. If you use short lengths of hard rubber or silicone tube, instead of the well-nuts, then you will need to add a rubber washer on the front face, instead of the flange on the well-nuts. Rubber washers can be easily cut from motorcycle tire inner tube with a sharpened brass tube. An M6 steel washer is used on the front face, under the head of the M6 bolt.

On the back face, between the carbon/ply plate and the aluminum standoffs, another 16mm (5/8") Ø rubber washer was added. Use Loctite on the M6 bolts that pass thru' the isolation mounts in the carbon plate to secure them firmly into the stand-offs - and be careful not to tighten the bolts up so much that you completely compress the rubber and eliminate the anti-vibration system! The photo (above) shows the order of assembly of the parts.

You need to cut a hole in the firewall for the rear-mounted 3W carburettor, and the 3W instructions include a full-scale drawing of the engine mount positions and carburettor which is very useful when making the mounting plate and carb cut-out.

We highly recommend that you fuel-proof all bare wood inside the motordome/tank base area with a thin coat of laminating resin, as these carbs can spray a thin mist of gas (petrol) from the venturi.

The header/manifold was custom-made to suit this installation, but it is quite long, which meant that we needed to shorten the entry into the Greve tuned pipe by 45mm to correct the tuned length.

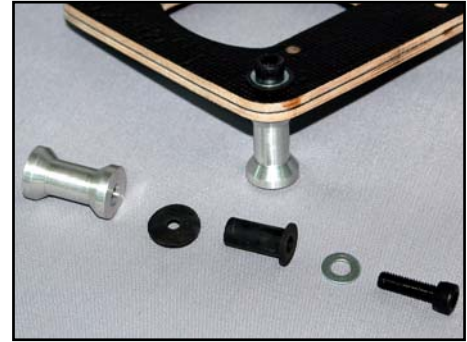

(above) Shows the order of assembly of the anti-vibration mounts in the carbon-ply mounting plate.

(below) Standoffs are bolted thru' the firewall with the supplied M6 x 20mm allen bolts & washers. M6 T-nuts are also included in the hardware, which can be used with some engine mount types.

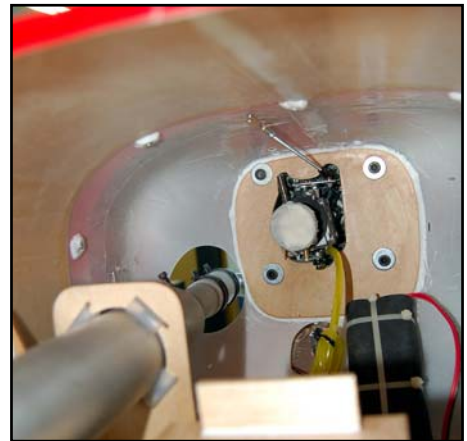

(above) 3W 80cc Xi motor installed, with custom header and Greve tuned pipe. Note position of Ignition unit, and cable -ties which secure the 2 receiver Nicads inside the motordome.

After first trimming flights we added a single thin 6mm ID washer behind the left side stand-offs and the motor dome, to increase the sidethrust very slightly - and also a thin washer behind both lower stand-offs which actually gave the very slight upthrust (approx +0.25 degree) required for perfect neutrality.

### **Tuned Pipe.**

Although a bit more complicated to install than a canister muffler, we fitted a tuned pipe as it gives some increased power, improved throttling characteristics and reduced noise levels - especially important in Europe where we have quite strict laws on this.

The pipe is supported at the front and back on 2 cnc milled plywood tuned-pipe mounts which are included in the kit (to suit Ø 49mm pipes), together with enough of the hard silicone tube to make the isolation mounts. Cut the silicone tube into 20mm lengths and insert in the milled slots as shown in the photos below/right. The front pipe mount is secured to the front face of the plywood landing gear mount with 2 sheetmetal screws (Ø 3.5 x 18mm), access is with a long X-head screwdriver thru' the 2 small holes seen lower right side in the photo above and P16.

The rear mount must be secured to a 3mm thick plywood reinforcing plate glued onto the side of the fuselage, as shown - and you can use two of the M3 bolts and T-nuts included in the spare hardware pack for this. We reinforced the fuselage at this point with a few carbon rovings, but in retrospect this was not necessary with the relatively low vibration levels experienced. Maintain at least 6mm (1/4") clearance between the bottom of the tuned pipe and the fibreglass sleeve around the wing tube, and check to make sure you can still access the front M6 plastic nuts used to secure the wings to the fuselage.

Make sure that the tuned pipe cannot move forward (or backwards) and touch against the end of the manifold, as the metal-to-metal contact could cause terminal R/C interference! 2 small sheet metal screws through the teflon joiners and pipe/manifold side walls prevent this. The 3W instructions include a full-scale drawing of the engine mount positions and carburettor which is very useful when making the mounting plate and carb cut-out.

You can see in photos P20 and P24 that we installed a thin balsa-composite plate against the left side of the fuel tank, & also above the left hand rudder phenolic servo arm, to prevent any possibility of heat damage.

### **Canister mount**

Depending on your header, you should find that a single canister (MTW TD110K shown here) will fit in front of the wing tube sleeve, but you will probably need put the canister on the oppo-

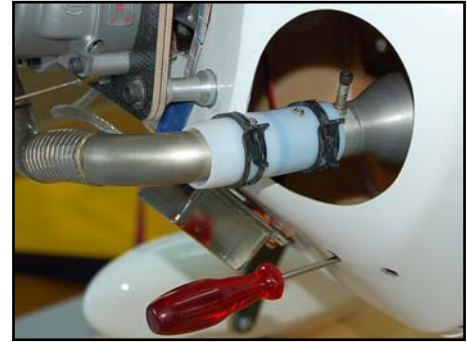

*(above) Prevent the canisters or tuned pipe moving forwards or backwards with 2 small sheetmetal screws thru' the teflon coupler(s). Screwdriver is for tightening sheetmetal screws in front mount.*

*(below) Rear pipe mount is secured to a 3mm thick scrap plywood plate glued securely to the fuselage side.*



site side of the fuselage to the cylinder - and use a 'cross-over' header to give you enough length.

Included in the kit is one cnc milled plywood mount to suit the TD110K, or similar 80mm diameter canister. Insert 20mm lengths of the hard silicone tube in the corner slots to make the isolation mounts, in the same way as shown for tuned pipe mounts. The plywood mount can be screwed to the front of the landing gear mount bulkhead with 2 of the Ø3.5 x 18mm sheetmetal screws included in the hardware pack.

Enlarge one of the semi-circular cutouts in the plywood bulkhead at the front of the landing gear mount as required. Make sure that there is at least 6mm (1/4") clearance between the bottom of the canister and the top of the carbon landing gear - as the heat could damaged it with extended exposure to the high temperatures. You can protect the top of the carbon, if needed, by adding a thin 'sacrificial' plywood plate, glued to the top of the carbon with clear silicone adhesive.

### Desert Aircraft DA-100

The DA-100 installation and set-up uses the same principles and motor centreline positions as detailed above. Because it is a twin-cylinder motor it has lower vibration levels and it is not necessary to incorporate an anti-vibration mount. The motor fits fully enclosed in the cowling.

The photos below show the DA-100 installation in one of our 2.6m 330L's (Futaba scheme) but, of course, as the motor-dome/firewall on the 300SX is 30mm further back you will need to use 30mm long engine standoffs to ensure a 5 - 6mm gap between the rear face of the spinner- backplate and the front of the cowling - instead of the short stack of washers shown here. Other than this the installation is identical.

Mark the horizontal and vertical motor centreline positions accurately on the front of the firewall in same manner as described at the beginning of this section, dependant on your spinner diameter. The 4 mounting holes for the DA-100 are 70mm apart horizontally, and 80mm apart vertically. Mark half of these dimensions equidistant either side of the centrelines and bolt the motor to the your standoffs. Drill the 4 mounting holes through the firewall, 6mm diameter, and secure the standoffs using the M6 x 20mm allen bolts and washers supplied in the hardware pack, with a little Loctite for security. If you need to adjust the thrustline very slightly after trimming flights, then add thin 6mm I.D washers between the front of the firewall and the back of the standoffs. (see photos P17 and P18)

Fit your headers/manifolds to the motor and cut the necessary holes in the lower part of the motor dome to suit.



*(above) A single 80mm Ø can (TD110K shown) can be fitted - but you may need to use a cross-over header to get the correct length.*

*(below) DA-100 mounted on a 330L. The mounting system is identical for the 300SX, except that you will need 30mm long stand-offs, and accurate thrustline alignment is even easier!*



*(above) MTW headers & canisters are available as optional items form C-ARF. Shown here are the TD75K cans and headers for the DA-100.*

### Canister and Header Installation

Shown here is the installation of a pair of MTW headers and TD75k canisters, as included in the optional set available from Composite-ARF. (see relevant webpage for details of currently available accessories & options).

The assembled canisters and headers are inserted into the fuselage through holes that you need to cut in the lower surface of the motordome, as shown in the photo below, but do not cut through the 25mm fibreglass joining tape in the centre of the motordome.

Included in the kit are 2 cnc milled plywood mounts to suit the TD75K canisters, or similar 70mm diameter cans (eg: Zimmerman). Insert 20mm lengths of the (included) hard silicone tube in the corner slots to make the isolation mounts, in the same way as shown for tuned pipe mounts. The plywood mounts can be screwed to the front of the landing gear mount bulkhead with 2 of the Ø3.5 x 18mm sheetmetal screws included in the hardware pack. No other support is needed. Install 2 of the small sheetmetal screws through each the teflon joiner into the canister entries and headers to make sure that the cans cannot slide forwards or backwards.

You can enlarge the semi-circular cutouts in the front of the landing gear support if needed for larger diameter canisters, but ensure a minimum 6mm (1/4") gap between the bottom of the cans and the carbon landing gear, as mentioned above, to prevent heat damage.

### Motor Cooling

It is imperative that your chosen motor not only receives sufficient air to cool it through the opening in the front of the cowl, but that the air is forced to go through the cooling fins of the cylinder(s) - otherwise the air will just take the easiest route and exit the bottom of the cowl without doing any cooling. In this case you will overheat, and damage, your valuable motor.

Depending on your motor you will need to make some sort of baffle to force the air through the cooling fins, and this can be made from scrap 1.5mm plywood or 3mm balsa. The full-size template at the end of this manual fits the cowling, positioned about 10mm below the bottom of the front cutout, and the back edge of the baffle can be adjusted slightly to suit your chosen motor.

Make the back edge of the baffle about 6mm (1/4") clear of the cooling fins of the cylinder(s) and the crankcase.

Glue the baffle plate into the cowl with epoxy. It looks neater if you paint it matt black first, using heat-proof spray

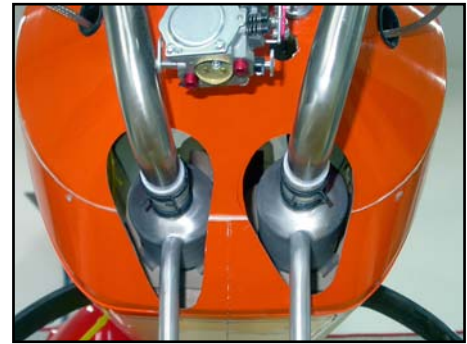

*(above) Cut large enough holes to insert the cans through the motordome, taking note of the cooling requirements mentioned here.*

*(below) Typical cnc milled plywood canister/tuned pipe mount & hard silicone tubing included in the kit to suit Ø 49mm pipes, and both Ø 70mm & 80mm canisters.*

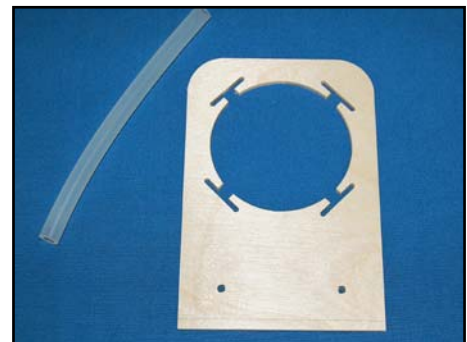

*(above/below) 2 views of sample engine baffles; the top one for a DA-100 and the bottom for a 3W.*



paint (as used for car manifolds/exhausts)

### Exhaust Cooling

Whatever type of exhaust system you chose to fit, make sure that the assembled headers and canisters, or pipe, can be inserted from the front, through the motor-dome - and make the hole(s) at least 18mm (3/4") bigger than the exhaust all around to ensure enough air enters the fuselage to cool the exhaust system.

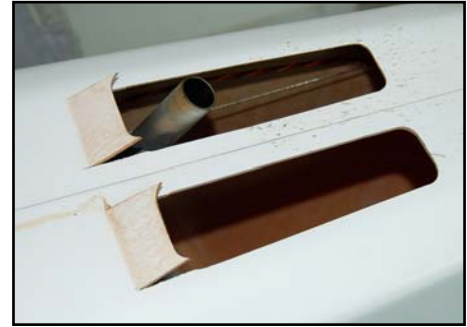

*Radius the corners of all air exits, and cut angled tabs at the front to create some turbulence here and make sure the air is sucked out.*

Of course, this warm air must also exit the fuselage - so you also need to cut sufficient air exits in the bottom of the fuselage. As a general rule the total area of the air exits must be at least double the inlet area. For example if the hole in the motor dome for the tuned pipe is 75mm (3") diameter (area = 4400mm<sup>2</sup>), then the total air exit area should be about 8800mm<sup>2</sup>. This is equal to 2 slots of 50mm (2") wide x 90mm (4") long.

The balsa fin post also has cnc milled cut-outs in it, to help prevent a build-up of hot air inside the fuselage. From our experience we have found that 2 slots, each of about 125mm x 45mm wide provide excellent cooling for both the 3W and DA-100 set-ups shown here.

Cut the air exit slots in the bottom of the fuselage with a sharp knife, and sand the edges to shape with 240 grit sandpaper - remembering to radius all the corners to help prevent tearing of the composite sandwich skin. It is advisable to reinforce the edges of the cutouts with either a few carbon rovings, or narrow strips of 3mm plywood. (see photo above)

It is also helpful to make small tabs at the front of the cooling slots to make sure that the warm air is sucked out of the fuselage. These can easily be made by making 2 cuts in the skin, about 20mm long, bending the skin outwards about 30 degrees, and creasing the inner surface with the back (blunt) edge of the knife blade. Hold in position, and apply a couple of drops of thin CA to the sandwich from inside the fuselage to maintain the angle. (See photo P21)

### Fuel Tank Base

The Fuel tank base is an integral part of the balsa/composite sheet assembly that also supports the rudder servos. It is sized to fit a Dubro 960 cc tank (part #690) perfectly, but can be adjusted to suit your tank. Depending on the size of your fuel tank, glue a scrap balsa block at the front of the tank base to stop the tank moving forwards. Secure the fuel tank to the tank base with 3 cable-ties as shown, through the milled slots.

**Note:** If you wish to fit the fuel tank base slightly off the centre of the fuselage - to give clearance for tuned pipe of large single canister, for example - you can lengthen the slot in the vertical balsa/composite bulkhead by up to 15mm to permit this. This slot is shown arrowed in photo P8.

Ensure that the semi-circular cutouts under the tank base are securely glued down to the fibreglass sleeve over the wing tube, with careful preparation, and using at least 30 minute epoxy and micro-balloons mixture.

Don't forget to add the short lengths of 1" fibreglass tape (with laminating epoxy) to reinforce the joint between the vertical balsa bulkhead behind the tank and the fuselage floor - and also between the rudder servo plate and the fuselage sides. See photos P10, P23 and P24.

## R/C & Gear Installation

Everyone has their own favourite methods and layouts when fitting the R/C and gear and the installations shown here, and on the full-colour photosheets, are just a guide, but have worked perfectly in all of our planes flown by C-ARF factory staff, and many of our customers.

You have several choices of R/C system. You could keep it simple, and use Dual receiver batteries and a Powerbox sensor switch, which includes a regulator and battery-backer, or you could go for a 'full-house' set-up using a high-quality servo powerbus system for the ultimate in safety and security. It's your choice, but the dual Nicad and powerbus installation does give extra 'peace of mind' and protects your investment, and therefore this is what C-ARF recommend and have shown here.

The PowerBox power control unit is designed especially for large models and provides dual battery inputs with hi-amp connectors, multiple outputs for 6 channels/24 servos (no 'Y' leads needed), automatic voltage regulation and stability, built-in servo amplifiers for those long servo cables, as well as dual visual LED battery displays. It comes complete with hi-current connectors and is fitted with anti-suppression chokes on all channels. The full 'PowerBox' range is available from C-ARF as an option. Please visit our website for more details.

### Ignition Batteries

Both examples shown here used a 2400 (sub-C sized cells) ignition Nicad. The 4-cell pack for the DA-100 was secured inside the front of the motor dome with cable-ties, and the 5-cell pack for the 3W motor was fixed to the underside of the motor baffle plate to move it as far forward as possible - for correct Centre of Gravity. Small plywood strips were glued to the balsa baffle to spread the load of the cable ties (photo page 28). The battery cables plug into a multiplex connector that is glued into the bottom of the motor dome, for ease of removing the cowling. (photo P16)

Make sure that all batteries, and other heavy items, are very securely fixed in the plane - remember how much they will effectively weigh when subjected to 4 or 5 G's!

### Receiver Batteries

In the DA-100 powered example we used two 5-cell 2400 Nicads (sub-C size) for the Powerbox, one installed in the motor dome and the other on the fuselage floor just behind the rudder servo plate. Both were cable-tied to a 3mm plywood plate, glued in with 30 minute epoxy and reinforced with small pieces of the 1" wide fibreglass tape.

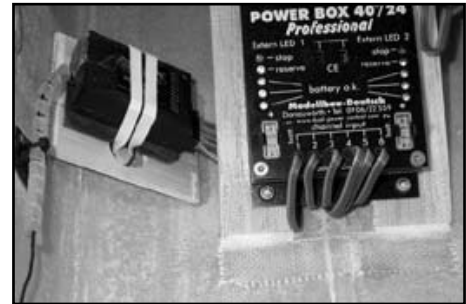

(above) The Powerbox can be screwed to the plate behind the rudder servos if using a DA-100.

(below) NiCad packs can be fitted to plywood plates on a thin rubber sheet, and secured with cable-ties.



(below) Powerbox, Receiver and switch location in the Extra 300SX.



To save weight in the 3W powered plane, we chose two 5-cell (AA-sized) 1400 mAH packs - and these were both fixed inside the front of the motor dome. No additional lead was required to achieve the correct Centre of Gravity. All battery packs should be wrapped in foam to isolate the soldered connections from vibration as much as possible.

### Receiver

We strongly advise that you position the receiver as far away from the high-voltage ignition unit as possible - at least 200mm (8") for the minimum interference risk. In the DA-100 version it was secured to the side of the fuselage, close to the angled plate behind the rudder servo mount which was used to locate the Powerbox.

In the 3W version, to get everything as far forward as possible, we positioned the Powerbox Evolution and the Receiver on a balsa-composite plate, glued to the top of the wing tube sleeve - on the right side of the tank base.

Please mount the sensitive Receiver on a rubber or foam sheet, at least 3mm thick, to isolate it from vibrations. You can easily secure the Rx by gluing a plywood stick across 2 large holes in the mounting plate - using 2 rubber bands around the Rx case. (see photo below)

### RX Antenna

In both cases the Rx antenna was routed to the side of the fuselage, then backwards along the fuselage side and out of the top of the fuselage immediately behind the canopy - and taped to the top of the fuselage. Secure it in short lengths of silicone tube to make sure it cannot be cut through by any sharp edges. Keep it as far away as possible from the cables for the elevator servos and the closed-loop rudder wires.

### Switches

Often regarded as the 'weakest-link' in an R/C system, it is very important to use quality switches for both Receiver/Powerbox and motor ignition, and we only use high quality switches from Power box. The electronic switch included with the Powerbox Evolution is a 'Fail-ON' type, as is the Powerbox 'Sensor' switch. We use the analog 20 Amp power-switches, also from powerbox, for the ignition system.

If fitting the switches into the outside surface of the fuselage, as shown, please reinforce the area inside with a small patch of 3mm thick plywood to reduce vibration transmissions to the switches. It only adds a few grams. The Powerbox switches come with paper templates, making it easy to cut the slots in the fuselage accurately.

### Servo Extension leads etc.

Please make sure that you use good quality twisted-cable extension leads, of heavy gauge wire with gold-contact connectors, to all the servos. Certainly we recommend that all servo leads and extensions longer than about 30cms (12") are fitted with ceramic chokes (ferrite rings) to prevent RF noise, at the receiver end - normally within 100mm (4")

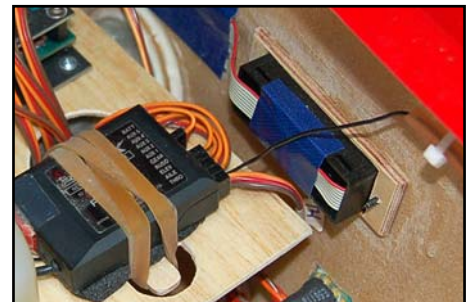

*(above) 3mm plywood reinforcing plate glued inside the cutouts in the fuselage sides for switches.*



*6-pin MPX connectors are used for extension leads, with one half mounted in the fuselage sides.*



of the receiver. Of course, if you are using a 'Powerbox' this unit is already fitted with all the ceramic chokes. Also no 'Y' leads are needed, as the powerbox provides multiple inputs for each channel.

At C-ARF we hard-wire all our servos with twisted cable leads of the exact length required and Multiplex 6-pin connectors (see photos on page 31). For the 2 aileron servos you can use 1 pin for each wire, and for the elevators you can gently squeeze pairs of adjacent pins together and use a pair of pins for each cable. We glue the female connectors into small plywood plates in the sides of the fuselage for connecting the stabs and ailerons when assembling the plane. Making up the proper extension cables and connectors is only a little work, if you are proficient with a small soldering-iron, and makes assembly of the model at the air-field very quick and easy! Once all wires are soldered to the gold-plated pins, fit a short length of heat-shrink tube over each one. Finally protect all the connections from vibrations etc with a nice blob of glue from a hot-glue gun. Job done.

Make sure that any plug/socket servo cable connections that cannot be easily seen and regularly checked, for example the servo connections in the wings, are secured together with tape - or a short length of heatshrink tubing as shown here. Also tape down any loose cables that could get trapped or caught in linkages.

### Throttle servo

You can install the throttle servo anywhere you want, using the milled plywood mount that we supply (photo right). In the 300SX we securely glued it to the underside of the top of the fuselage, with epoxy/milled fibre mixture, just in front of the fuel tank.

In a plane with a DA-100 and dual canisters, you will be able to glue the mount to the side of the fuel tank base and use a balsa or carbon-tube pushrod through the firewall to the carburettor. We advise you *not* to mount it directly on the back of the firewall, due to higher vibration levels which can quickly 'kill' the servo. Note that all DA motors need quite a lot of servo throw to get the full throttle range, so make sure you can fit a long output arm on the servo.

M3 all-thread, steel clevises and locknuts are included in the hardware pack to make up your throttle pushrods.

Make up a wire lever so that you can operate the 'Choke' for starting thru' the cut-out in the front of the cowling. In the 3W installation this wire is very long, because of the rear-mounted carb, so the wire pushrod passes through a length of silicone tube in the bottom of the carbon plate to support and isolate it. (see photo P14)

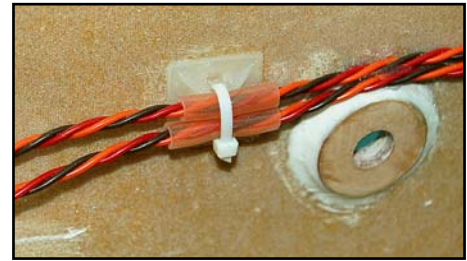

*(above) Protect all wires and tubes where they pass thru' bulkheads, or near sharp composite parts, with a short length of silicone tube, and fix firmly in position.*

*(below) Secure all hidden servo plugs/sockets with heatshrink.*

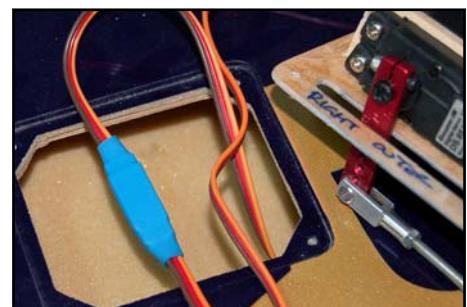

*(above) Throttle servo mount assembled from milled plywood.*



### Motor Ignition System

The ignition unit is normally fixed to the motordome, as close to the engine as possible - because of the length of the HT leads that connect to the spark plug(s). Mount it on a foam pad and secure with cable-ties, or use sheetmetal screws into small plywood pads with rubber grommets for vibration isolation. Don't forget that the ignition unit also gets warm during use, so it is wise to put it in a location where there is some cooling airflow.

Use a very small cable tie, 'safety clip', or a length of heat-shrink tubing to securely connect the plug and socket from the motor pick-up to the ignition unit.

### Fuel Tank

The fuel tank is held to the tank base with 3 large cable-ties (photo on page 29 and P23). Drill a hole in the motor fire-wall if necessary for the fuel feed tube from the tank to the carburettor, and protect it where it passes through the hole using a rubber grommet or similar. Fix the tubing securely to the underside of the top of the motordome with a couple of cable-ties or equivalent, to make sure that it cannot come in contact with the headers or hot exhausts.

Fit the correct stopper to the fuel tank for the fuel type used.

(If using Dubro tank the gasoline stopper has a small 'O' moulded in the top of it). We use the excellent 'Tygon' brand of fuel tubing for all our aerobatic models. It is totally gasoline and kerosene-proof, and does not go hard and crack with age. Secure the feed tube inside the tank to the clunk with a small cable tie. If the tube is even a little loose on the brass tubes through the stopper, you can be sure it will come off at just the wrong moment and your engine will quit ! Therefore please solder some small rings onto both ends of the brass tubing (easily made from the soft wire of a paperclip wrapped around a small screwdriver, or short lengths of brass tube) and also secure with a fuel-line clamp or cable-tie. Don't miss this small detail - it could cost you your plane !

We use the normal 3 tube plumbing system, one from the clunk to feed the motor, one out of the bottom of the plane (vent/overflow - leave open) and one at the top for filling (close for flight).

If you want to fit a smoke system the smoke tank can be fitted alongside the fuel tank but you will need to make an extra platform for it. Follow the manufacturers instructions for fitting the smoke system.

### Final Check

Now check that you have fixed all components securely. Keep in mind that all the components inside the aircraft are loaded with the same G's as the wing and the wing spar during aerobatic manoeuvres. Check engine, cowling, wing and stab mounts carefully again.

- Are all extension leads, cables & fuel tubes securely fixed to the side of the fuselage and cannot come loose when subjected to high 'G' forces during flight.

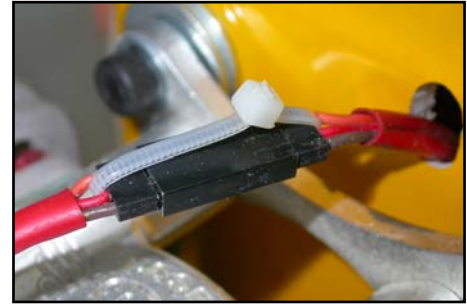

*(below) Secure the connectors between the motor & ignition unit. (below) Fit barbs to all brass tubes and fuel connections for safety. Easily made from a paper-clip, soldered onto the brass tubes.*



- Are all tubes and wires protected from chafing where they pass thru' the holes in fibre glass parts or bulkheads with rubber grommets, or short lengths of split silicone tubing?
- Especially if you have installed the internal mini-pipe set-up, you also must make sure that no fuel tubing or wires can come into contact the exhausts. Use the plastic spiral-wrap to tidy up groups of cables and make sure that they cannot move around in the plane under high 'G' manoeuvres by fixing them to the sides with small cable ties. If using the easily-available cable-tie plastic fixing plates, please do not trust the double-sided tape that they usually have on them which can fail under vibrations. Peel it off, rough up the back face with coarse sandpaper and glue to the fuselage sides with 30min. epoxy.
- Did you fit small Tygon or silicone tube pieces over all the clevises?
- Did you tighten the M3 locknuts against all the clevises to make sure they cannot turn?
- Are the swages crimped up nice and tight on the rudder cables?
- For added security add one small drop of loctite/thread locking compound on all the bolts that hold the servo arms to the servos, especially important with digital types.

Then you can go on set up all the linkages, control throws and R/C system as described below.

## Setting Up Your Aircraft

### Centre of Gravity:

Set the Centre of Gravity to 90 - 100mm (3.3 - 4") from the leading edge at the wingtip for the 1st flights. Hold it with a helper at both wing tips in this position and make sure the plane balances horizontally. This is the 'pattern' CG position.

After you are confident with the plane, you can move it backwards by up to 20mm (7/8") maximum, but this is definitely a '3D - Freestyle' CG setting and should not be used for the first flights. With this rearward CG you will need to use the high rate control throws shown below.

Don't forget to balance the plane laterally, holding the spinner central bolt and a fingertip under the rudder and, if necessary, add a small weight to the light wing tip to make it track correctly.

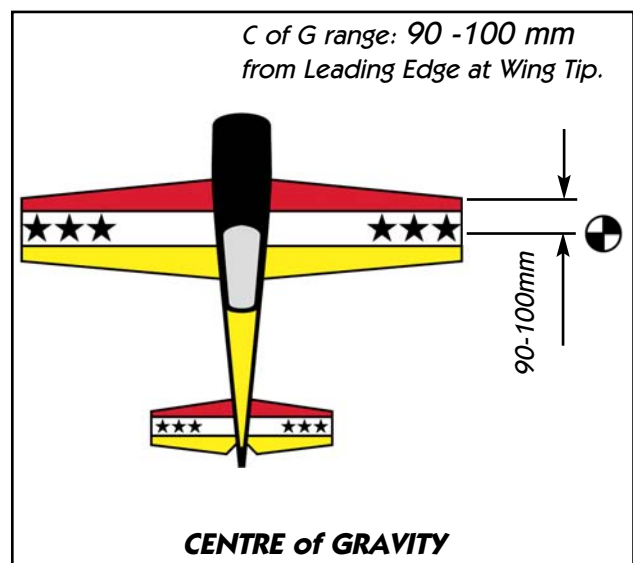

**Engine Thrustline:**

Already given in the instructions, down thrust should initially be set at 0° degrees and right thrust 2.5 - 3 degrees, depending on the prop used. We recommend a 27 x 10 on a 75 - 80cc motor, and a 28 x10 carbon prop for any 100cc engine. It is a very quiet and powerful solution. They are normally CNC-designed, so the prop is balanced perfectly statically, dynamically and aerodynamically, which keeps the vibration down to a minimum.

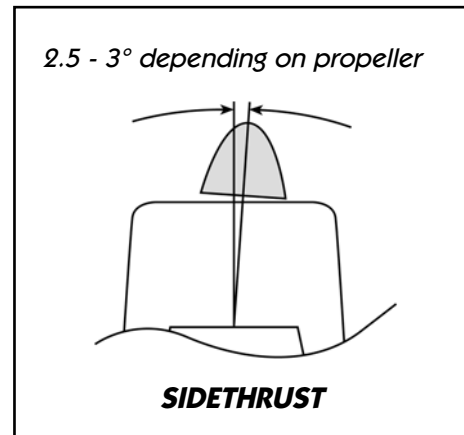

**Control Throws:**

All measurements are at the root/trailing edge position. All controls should be set with a dual rate switch.

**Elevator**

On high rate the elevator should really be at maximum, up to 50 degrees both sides (approx. 100mm), but in this case with 50% exponential. Low rate should be no more than 50mm (2") both sides. This is the perfect throw for nice and crisp snaps. If you like you can add about 20% exponential to the low rate setting as well.

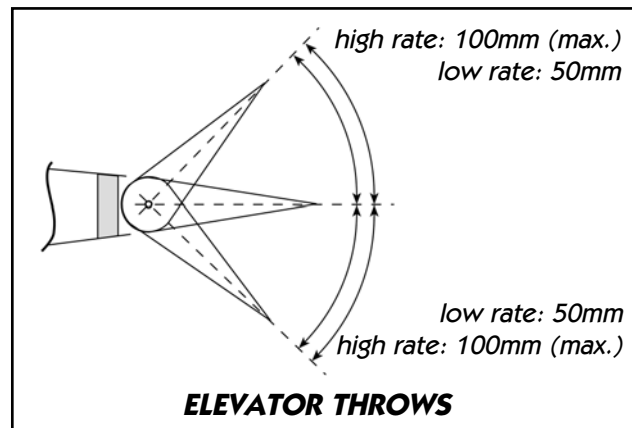

**Rudder**

Set the high rate to maximum throw (about 150mm) both sides, and at low rate reduced to about 100mm. The Extra needs quite a lot of rudder for nice stall turns, so you should at least add 25% exponential for smooth tracking corrections. At the same time you should remember that the Extra rudder is very sensitive, and the plane starts shaking at high speed if the rudder linkage is not really rock solid. So check your linkages and closed-loop cables again and make sure that there is NO slop at all ! On the other hand these characteristics are also the reason for best rudder sensitivity at the slowest 3D-speeds.

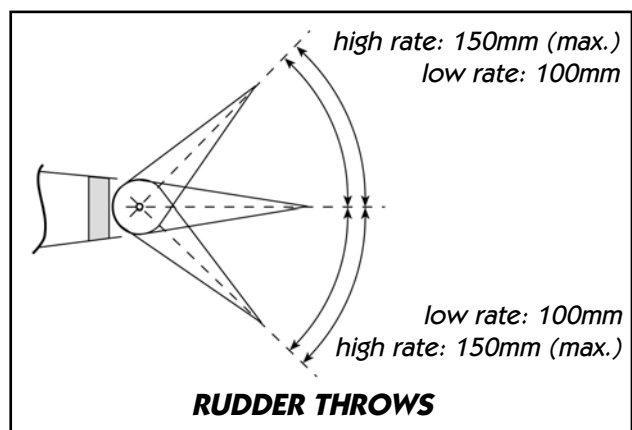

**Ailerons**

Aileron throw for high rate is 65mm up and down (measured at root). Use at least 30% exponential at high rate. For low rate you should decrease the throw to the TOP to 45mm, to the BOTTOM to 50mm. Yes, you're right - this is a reversed differential due to the hinge line being in the top skin instead of on the centre line. You will have to finalise this differential figure

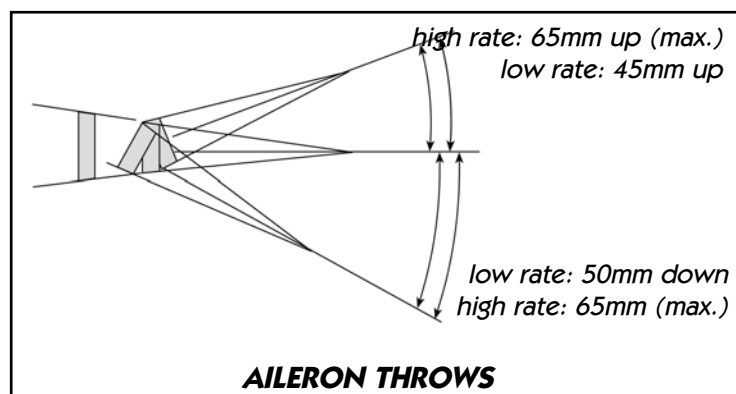

during flight, as mentioned earlier in this instruction book. At high rate, for 3D maneuvers, this doesn't effect the rolling too much, so you can maximize the throws to whatever is mechanically possible, even more up than down if you wish. You may need to lengthen the slots in the servo hatches by 2mm or so at the front to obtain these high rate throws.

## General

Your Extra has very large control surfaces. This makes it very sensitive and reactive. It is always possible that these huge control surfaces can flutter at high speeds if the assembly, servo installation and linkages are not made perfectly, and if a servo gear or output disc/arm strips the flutter will not stop until the plane hits the ground....

So please do yourself a favour, and make sure that you only use the best servos available, and take the utmost care making your linkages. Check every linkage for slop, and rather reduce the maximum throw than risking a high speed flutter due to sloppy servo gear or linkages. To prevent this for sure, we recommend reduced control travels (reduced by using short servo arms, not by using electronic settings). Using 2 servos per control surface as described in this manual will never overload or damage high quality servos, even if the maximum travel of each servo is slightly off. The aileron control surfaces have enough torsion flexibility so that damage to the servos should not occur.

The Composite-ARF aerobatic models are known for very good and crisp 'snapping', and we think that this is also true for the 2.6m 300SX version. It's like an explosion ... and it still stops immediately that the sticks are released. Be aware of this fact when you try it for the first time. The trick for nice crisp 'snaps' is to stall the plane with a quick hit of 'up' elevator, and then release the elevator to zero, while you give full rudder and aileron together. But of course, you know this needs some practice to make it perfect every time !

Perfect knife edge tracking is achieved by mixing in slight up elevator, and opposite aileron to the rudder movement. From our experience as little as 6 - 7% 'up' elevator and 2 - 3% of opposite aileron are needed.

Now your Extra seems to be ready for the first flight. Always keep in mind, that you have a rock solid, but still sensitive, contest tool in front of you, which, if used as it is designed will give you many hours of pleasant flights. The performance of this aircraft is unlimited, and if maintained regularly and carefully, you will enjoy it's performance for many, many hours. With this aircraft you have the potential to move up to the unlimited "cracks". It's up to you now - you can't blame it on the aircraft anymore....!

We hope that you enjoyed building your Extra 300SX. Please let us know if you think that any hardware is missing or inadequate. We tried to make this airplane as complete as possible. With good feedback from customers you will help us to continue making good things even better. We appreciate your comments very much.

Email: [feedback@composite-arf.com](mailto:feedback@composite-arf.com)

Have Fun!

*Your Composite-ARF Team*

# Appendix:

## Extra 300SX, 2.6m Kit (version 1.0)

### Kit Contents

<i>Quantity</i>	<i>Description</i>
1	Fuselage
1	Wing, right (with 2 servo hatches taped in place)
1	Wing, left (with 2 servo hatches taped in place)
1	Stab, right
1	Stab, left
1	Elevator, right
1	Elevator, left
1	Rudder
1	Cowling
1	Protection bag set (wing, stab and rudder)
1	Canopy frame
1	Wheel pant, right
1	Wheel pant, left
1	Cuff for LG (right)
1	Cuff for LG (left)
1	Landing gear, carbon, right
1	Landing gear, carbon, left
1	Wing tube aluminum Ø 40mm x 1040mm.
1	Stab tube aluminium Ø 20mm x 300mm.
1	Clear canopy
2	Elevator hinge aluminum tube, Ø 4mm x 475mm. (packed in elevators)
1	Rudder hinge wire, Ø 2mm x 500mm (packed in rudder)
1	Milled wood/phenolic parts bag
1	Hardware bag
1	Instruction Manual (English)

### Hardware List

#### Fuselage Pack

<i>Quantity</i>	<i>Description</i>
4	Allen Bolt M6 x 40mm (engine mounting)
8	Washers, M6, large (engine mounting)
4	T-nut, M6 (engine mounting)
9	Allen bolt, M3 x 12 (cowling)
9	Washer, M3 (cowling)
9	T-nut, M3 (cowling)
4	Allen bolt, M6 x 20mm (landing gear fixing)
4	Washer, M6 (landing gear fixing)
2	Allen bolt, M6 x70mm (wheel axle)
4	Wheel collar, 6mm I.D, no set-screws. (wheelpants)
6	Washer, M6 (wheelpants)
2	Nut, M6 (wheelpants)
2	Stop-Nut, M6 (wheelpants)
2	Allen bolt, M3 x 16mm (wheelpants)
2	T-nut, M3 (wheelpants)
2	Washer, M3 (wheelpants)
2	Silicone tube, Ø10 x 150mm (muffler mounts)
4	Allen bolt, M4 x 8mm (canopy frame fixing)
4	Plastic Nut, M6 (wing mounting)

2	Nut, M3 (throttle linkage)
1	Clevis steel, M3 (throttle linkage)
1	All thread, M3 x 125mm (throttle linkage)
1	Ball-link, M3 (throttle linkage)
1	Stop Nut, M3 (throttle linkage)
1	Fibreglass band, 25mm x 300mm (tank base fixing etc)
4	Sheetmetal screws, Ø3.5 x 18mm (exhaust mount fixing)

### **Wing Pack (2 sets)**

<i>Quantity</i>	<i>Description</i>
8	Sheetmetal screws, Ø2.9 x 10mm (servo hatch fixing)
8	Sheetmetal screws, Ø2.9 x 13mm (aileron servo fixing)
4	Bolts, M2 x 15mm (secure phenolic arms to servo discs)
4	Nuts, M2 (secure phenolic arms to servo discs)
2	All-thread, M3 x 45mm (linkages)
4	Clevis, steel, M3 (linkages)
4	Nut, M3 (linkages)

### **Stab Pack (2 sets)**

<i>Quantity</i>	<i>Description</i>
4	Sheetmetal screws, Ø2.9 x 13mm (elevator servo fixing)
2	Bolts, M2 x 15mm (secure phenolic arms to servo discs)
2	Nuts, M2 (secure phenolic arms to servo discs)
1	Allen bolt, M3 x 20mm (stab tube security)
1	T-nut, M3 (stab tube security)
1	All-thread, M3 x 45 (linkages)
2	Clevis, steel, M3 (linkages)
2	Nut, M3 (linkages)

### **Rudder Pack**

<i>Quantity</i>	<i>Description</i>
8	Sheetmetal screws Ø2.9 x 13mm (rudder servo fixing)
4	Allen bolts M3 x 16 mm (ball-links to phenolic discs)
4	Bolts, M2 x 15mm (secure phenolic arms to servo discs)
4	Nuts, M2 (secure phenolic arms to servo discs)
4	Stop Nuts, M3 (ball-links to phenolic discs)
2	All thread, M3 x 55mm (ball-link to ball-link)
4	Ball-links, M3 (servo linkages)
1	Steel cable, 0.8mm x 2800mm (rudder linkage)
4	Crimping tubes, I.D. 2.6mm (rudder linkage)
2	Threaded ends for cables, M3 (rudder linkage)
2	Nuts, M3 (for threaded ends)
2	Clevis, steel, M3 (rudder connection)

### **'Spare' hardware pack**

\* This bag contains a few extra items that might be useful in the event of future maintenance or repair.

2	Ball-links, M3
2	Phenolic control surface horns
2	All-thread, M3 x 150mm
2	Allen-bolt M3 x 20mm
2	Stop Nut, M3
1	Allen Bolt M6 x 70mm
2	Allen bolt, M4 x 12mm
2	T-nut, M4
2	T-nut, M3

**Available Accessories:**

- Tail gear setup with 50mm Ø wheel, size 'L'. (product #801000)
- Spinner, Ø 120mm, alu. backplate & carbon spinner (product #810100 - 810103)
- Desert Aircraft DA-100 motor (product #950000)
- Canister set for DA-100 (product # 910100)
- PowerBox 40/24, dual NiCad crossover unit. (product #960200)
- PowerSwitch, pair, 20A, for dual NiCads (product #960300)

\* Please check our website : [www.composite-arf.com](http://www.composite-arf.com), for current availability of options and accessories.



*(above) Contents of the complete kit*



*(above) Contents of Fuselage hardware pack*

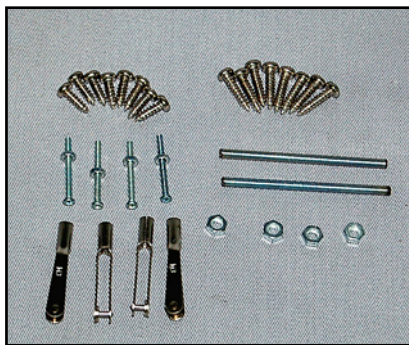

*Contents of Wing Hardware pack (2 sets)*

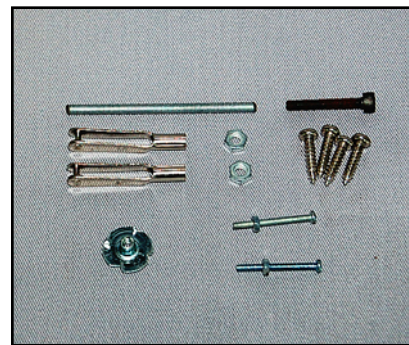

*Contents of Stab Hardware pack (2 sets)*



*(above) Contents of Rudder Hardware pack*

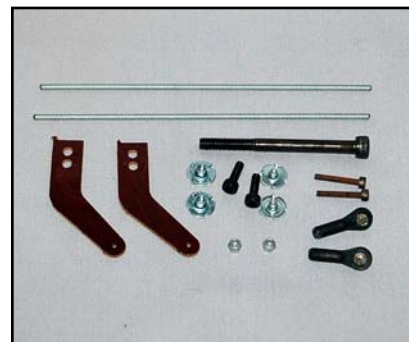

*(above) Contents of Spare Hardware pack*

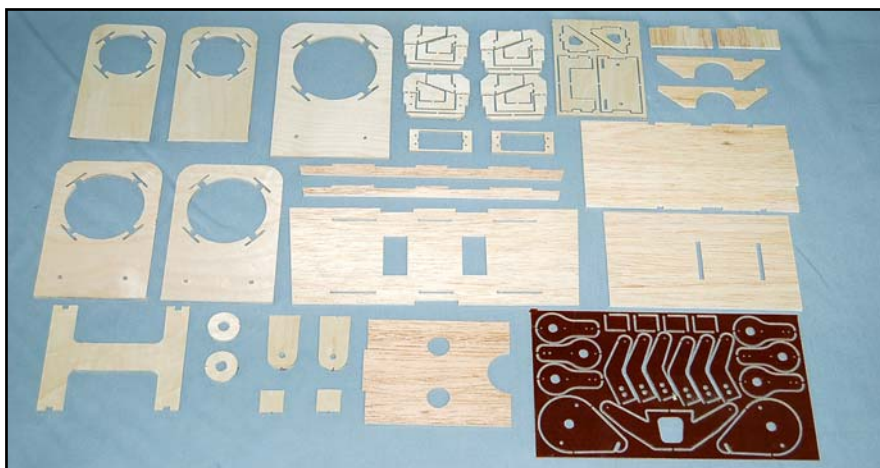

*(above) Contents of Milled wood and Phenolic pack*



**Full-sized Baffle template for Extra 300SX, 2.6m span.**

